

RSX

EXTREME FORCE HYDRAULIC CLASS ELECTRIC ACTUATORS









RSX Extreme Force, Hydraulic Class Electric Actuator

WHAT IS THE RSX?

RSX actuators are high capacity industrial actuators that can be an ideal choice for replacing hydraulic cylinders. These high force electric actuators are available for forces up to 66,000 lbf (294 kN). Designed for 100% duty cycle, rugged service and long life. The RSX utilizes planetary roller screws and ball screws for long lasting consistent performance. Additionally, the RSX uses Tolomatic's Your Motor Here program which allows RSX to easily mount many servo motor and gearboxes on the market.

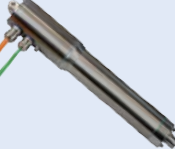

TOLOMATIC'S ELECTRIC ROD-STYLE ACTUATORS

	ERD	RSH	RSA	RSX	GSA	Combined Actuator & Motor	
						IMA	IMAS
							
	Rod-Style Actuator	Hygienic Rod-Style Actuator	Rod-Style Actuator	High Force Rod-Style Actuator	Guided Rod-Style Actuator	Integrated Servo Actuator	Hygienic Integrated Servo Actuator
Force up to:	2 kN (500 lbf)	35 kN (7,900 lbf)	58 kN (13,000 lbf)	294 kN (66,000 lbf)	18 kN (4,100 lbf)	36 kN (8,000 lbf)	11 kN (2,500 lbf)
Speed up to:	1.0 m/sec (40 in/sec)	0.5 m/sec (20 in/sec)	3.1 m/sec (120 in/sec)	0.8 m/sec (30 in/sec)	3.1 m/sec (120 in/sec)	1.3 m/sec (50 in/sec)	0.5 m/sec (20 in/sec)
Stroke Length up to:	0.6 m (24 in)	1.2 m (48 in)	1.5 m (60 in)	1.5 m (59 in)	0.9 m (36 in)	0.5 m (18 in)	0.5 m (18 in)
Screw/Nut Type	Solid & Ball	Ball & Roller	Solid, Ball & Roller	Ball & Roller	Solid, Ball & Roller	Ball & Roller	Ball & Roller

For complete information see www.tolomatic.com or literature number:

Literature Number:	2190-4000	2100-4010	3600-4233	2171-4001	3600-4231	2700-4000	2700-4014
---------------------------	-----------	-----------	-----------	-----------	-----------	-----------	-----------

(Not all models deliver maximum values listed, i.e.: Maximum thrust may not be available with maximum speed)

RSX Extreme Force, Hydraulic Class Electric Actuator

Applications

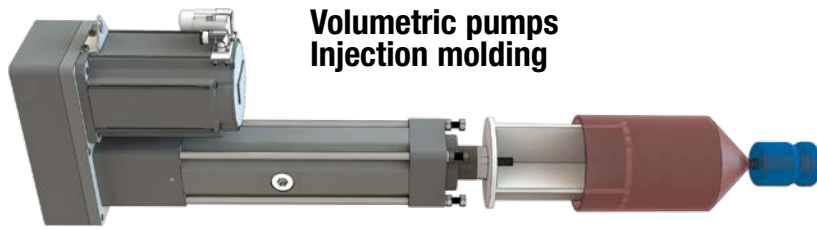

**Volumetric pumps
Injection molding**



**Motion
simulators**

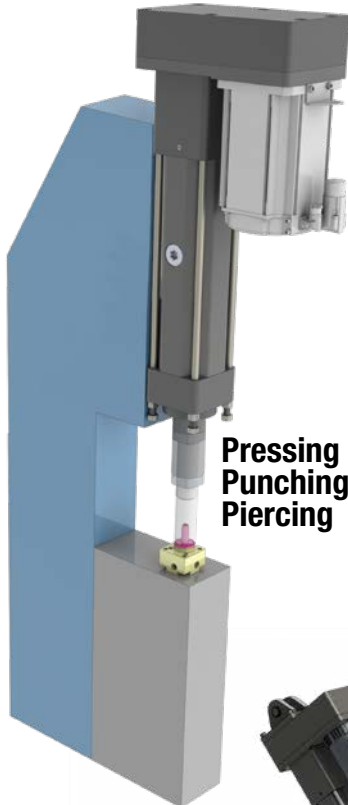

**Pressing
Punching
Piercing**

Other Applications:

- Active Security Barrier
- Assembly machinery
- Automatic tool changers
- Automotive
- Clamping
- Converting
- Cycle testing
- Fillers
- Formers
- Hydraulic replacement
- Machine tools
- Open / close doors
- Parts clamping
- Piercing
- Precision grinders
- Product test simulations
- Pressing
- Punching
- Riveting / fastening / joining
- Sawmill equipment
- Stamping
- Tension control
- Test stands
- Tube bending
- Wave generation
- Web guidance
- Welding
- Wire winding
- and many more



**Cut-Off &
Other Timber
Applications**

CONTENTS

What is the RSX?	2
Applications	3
Standard Features	4
Optional Features	6
Performance	8
Dimensions	12
Switches	15
Application Data Worksheet	17
Selection Guidelines	18
Ordering	19
Other Tolomatic Products	20

RSX ELECTRIC ROD-STYLE ACTUATOR

Tolomatic... MAXIMUM DURABILITY
EXCELLENCE IN MOTION

ENDURANCE TECHNOLOGYSM

A Tolomatic Design Principle

The RSX series high force electric actuators are designed for rugged service, long life and are an ideal choice for replacing hydraulic cylinders.

Endurance Technology features are designed for maximum durability to provide extended service life.

IP65 STANDARD

Protection against dust and water spray (static)

IP67 OPTION

For increased water ingress protection and scraper on thrust rod

HIGH POSITIONAL ACCURACY

SCREW ACCURACY

Roller Nut	± 0.0102mm/300mm	± 0.0004"/ft.
Ball Nut	± 0.102mm/300mm	± 0.004"/ft.

SUPERIOR CONSTRUCTION

- Steel parts are black or clear zinc plated for corrosion resistance
- Aluminum parts are Type III hardcoat black anodized for high surface hardness

FIELD REPLACEABLE CARTRIDGE

- Scraper and dual seal design prevent contaminants from entering the housing for extended life of the actuator
- One piece assembly designed for easy field replacement

YOUR MOTOR HERE

YOU CAN CHOOSE:

- Specify the motor to be installed and actuator ships with proper mounting hardware
- Specify and ship your device to Tolomatic for factory installation

LUBE ACCESS PORT

- This re-lubrication system provides extended screw service life
- Convenient lubrication without disassembly
- Grease zerk fitting

INTERNAL ANTI-ROTATE

Composite bearings prevent rotation of the thrust tube

MOTOR ORIENTATION

YOU CAN CHOOSE:

- Inline option directly couples the driving shaft
- Reverse-parallel option minimizes the overall length and offers a belt reduction drive with a 1:1 or 2:1 ratio

HIGH POWER TIMING BELT

Carbon fiber tensile reinforced synchronous belt to ensure smooth transmission of high torques in a compact design.

HIGH FORCE ANGULAR CONTACT BEARINGS

Four ball bearings to support high axial loads & forces for long life

MOUNTING OPTIONS

- Front Flange
- Extended Tie Rods
- Trunnion
- Mounting Plates

ROD END OPTIONS

- Rod Clevis
- Threaded Rod (standard)
- Extended Rod

SENSOR OPTIONS

- Solid state NPN, PNP or reed
- Tie Rod Clip

OIL COOLED

- For extended high duty cycle/high force performance (pg. 7)

THRUST TUBE

- Steel thrust tube supports extremely high force capabilities
- Salt bath nitride treatment provides excellent corrosion resistance, surface hardness and is very resistant to adherence of potential contaminants

NOSE BEARING

- Support the thrust tube and nut assembly through entire stroke length
- Unique nose bearing material allows for smooth operation

HEAVY DUTY INTERNAL BUMPER

Bumpers protect the screw and nut assembly from damage at both ends of stroke

ADVANCED SCREW TECHNOLOGY

- Precision ground planetary roller screws provide the highest force and life ratings available
- Ball screw option also available

BREATHER/PURGE PORTS

- Standard feature on RSX actuators
- Located on both the bottom and the opposite side of the actuator
- Use as Breather Port: allows air flow into the interior of the actuator. Prevents additional load on the motor caused by air buildup due to fast cycling of the RSX. Use as Purge Port: positive pressure with air lines and filters prevent contaminants from entering the interior of the actuator.

FOOD GRADE RSX

See page 11 for details

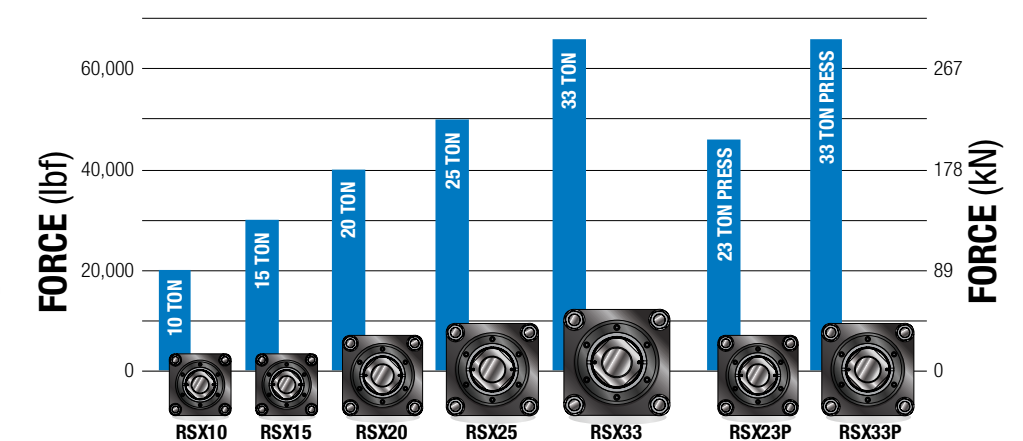

RSX PRESS MODEL

Tolomatic™
EXCELLENCE IN MOTION
...**MAXIMUM
DURABILITY**

ENDURANCE TECHNOLOGY™ A Tolomatic Design Principle

Endurance Technology features are designed for maximum durability to provide extended service life.

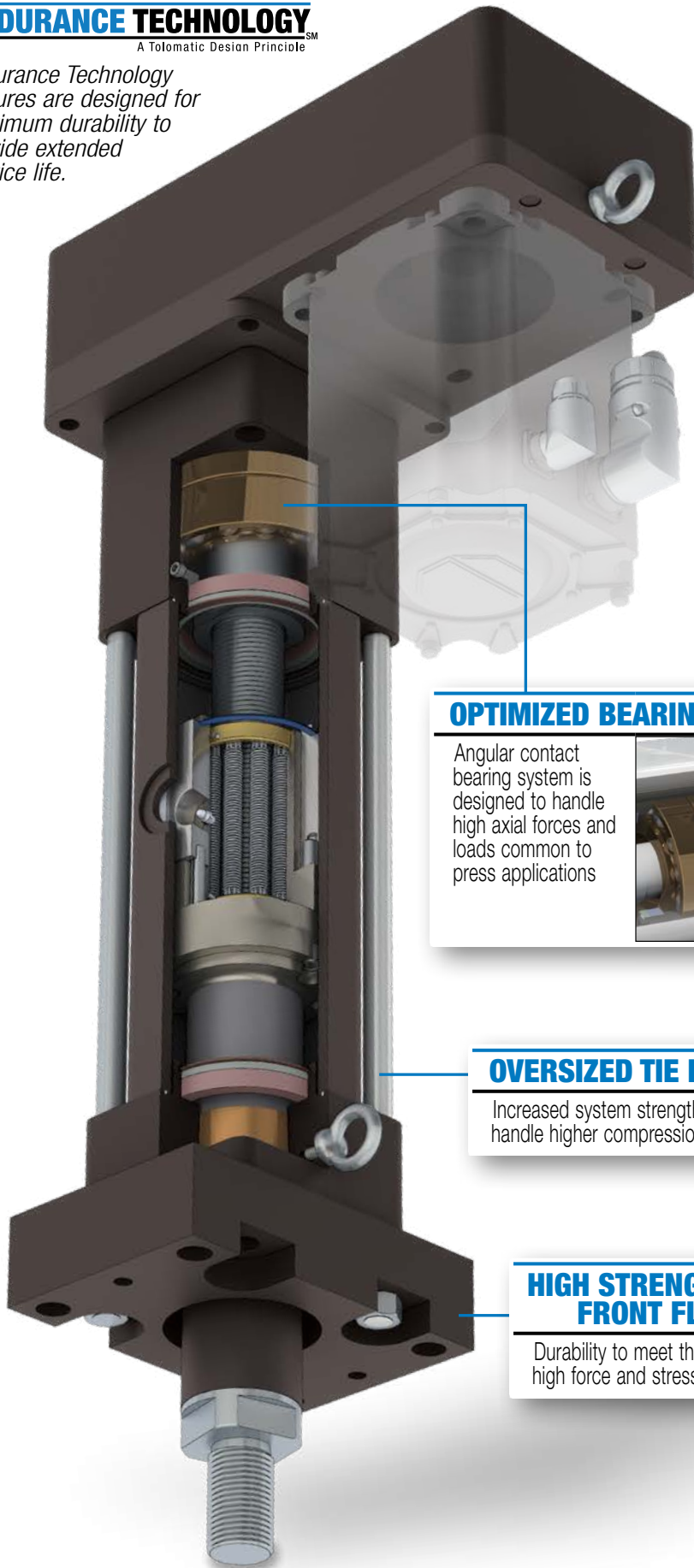

The RSX23P & RSX33P press actuators expand the compression force capability to 23 & 33 tons (46,000 & 66,000 lbf) making them well suited for applications such as pressing, riveting, clinching and many others. These press models have the same features as the standard RSX on pages 4 & 5 plus oversized tie rods, a bearing system optimized for high force extend, and a high strength steel front flange.

OPTIMIZED BEARING SYSTEM

Angular contact bearing system is designed to handle high axial forces and loads common to press applications

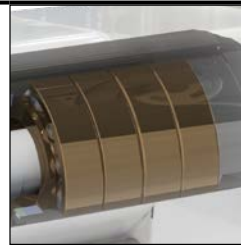

OVERSIZED TIE RODS

Increased system strength to handle higher compression forces

HIGH STRENGTH STEEL FRONT FLANGE

Durability to meet the demands of high force and stress applications

RSX OIL COOLED OPTION

RSX ACTUATORS

- An ideal choice for replacing hydraulic cylinders
- Available for all RSX sizes
- Designed for 100% duty cycle, rugged service and long life

OIL COOLED OPTION

- Provides up to 2 times the work capacity compared to standard grease RSX actuators.

ENDURANCE TECHNOLOGYSM

A Tolomatic Design Principle

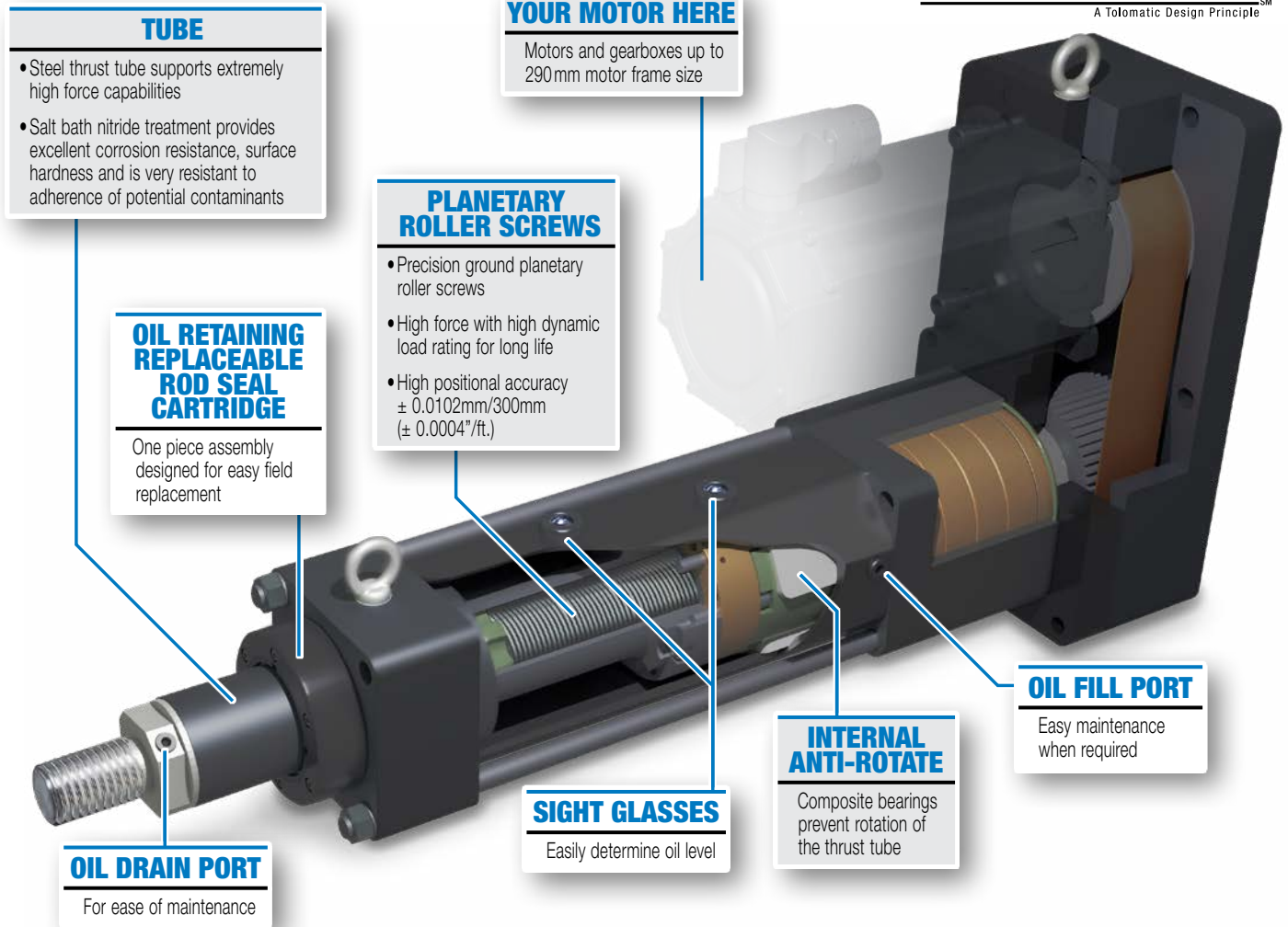

What does Oil Cooled mean?

An unpressurized synthetic oil bath around the screw and nut replaces the standard (extreme temperature and pressure rated) grease. The oil bath efficiently reduces internal temperatures while simultaneously providing lubrication.

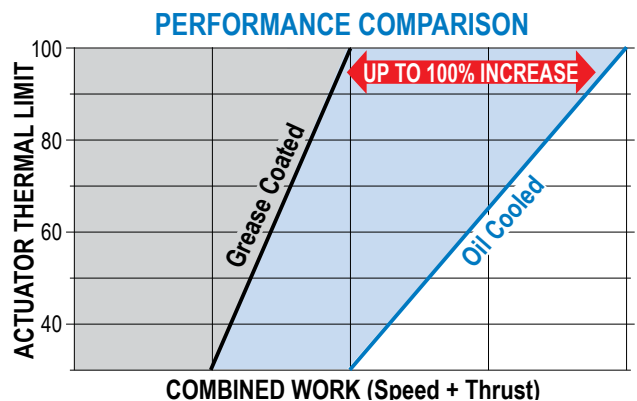

Please contact Tolomatic for performance of other oil cooled RSX sizes

RSX Extreme Force, Hydraulic Class Electric Actuator

Specifications

RSX SIZE (TONNAGE RATING)	SCREW CODE	MIN. STROKE in	MAX. STROKE		SCREW LEAD turns/in	LEAD ACCURACY in/ft	BACKLASH in	MAX. FORCE lbf	MAX. SPEED in/sec	DYNAMIC LOAD RATING lbf	DYNAMIC TORQUE TO OVERCOME FRICTION
			STANDARD in	EXTENDED*							
10	BN01	—	59.1	—	1.00	0.0040	0.0150	20,000	25.0	22,500	55.0
10	BN02	—	59.1	—	2.00	0.0040	0.0150	20,000	11.0	37,420	55.0
10	RN12	3.0	37.8	50.0	2.12	0.0004	0.0012	20,000	30.0	58,921	55.0
15	BN01	—	59.1	—	1.00	0.0040	0.0150	30,000	25.0	22,500	55.0
15	BN02	—	59.1	—	2.00	0.0040	0.0150	30,000	11.0	37,420	55.0
15	RN12	3.0	37.8	50.0	2.12	0.0004	0.0012	30,000	30.0	60,541	55.0
20	RN12	3.0	37.8	50.0	2.12	0.0004	0.0012	40,000	30.0	60,541	55.0
25	RN10	3.0	26.0	48.0	2.54	0.0004	0.0012	50,000	20.0	99,519	75.0
33*	RN10	3.0	48.0	48.0	2.54	0.0004	0.0012	66,000	20.0	99,519	75.0
23P*	RN12	3.0	28.0	—	2.12	0.0004	0.0012	46,000**	30.0	60,541	55.0
33P*	RN10	3.0	26.0	39.0	2.54	0.0004	0.0012	66,000**	20.0	99,519	75.0
		mm	mm	mm	mm/rev	mm/300mm	mm	kN	mm/sec	kN	
10	BN01	—	1500	—	25.4	0.102	0.381	89	640	100.09	6.21
10	BN02	—	1500	—	12.7	0.102	0.381	89	280	166.45	6.21
10	RN12	76.2	960	1270	12.0	0.010	0.030	89	760	262.09	6.21
15	BN01	—	1500	—	25.4	0.102	0.381	133	640	100.09	6.21
15	BN02	—	1500	—	12.7	0.102	0.381	133	280	166.45	6.21
15	RN12	76.2	960	1270	12.0	0.010	0.030	133	760	269.30	6.21
20	RN12	76.2	960	1270	12.0	0.010	0.030	178	760	269.30	6.21
25	RN10	76.2	660	1220	10.0	0.010	0.030	222	510	442.68	8.47
33*	RN10	76.2	1220	—	10.0	0.010	0.030	294	510	442.68	8.47
23P*	RN12	76.2	710	—	12.0	0.010	0.030	205**	760	269.30	6.21
33P*	RN10	76.2	660	990	10.0	0.010	0.030	294**	510	442.68	8.47

*Call Tolomatic for availability **Max force only available in compression (extend)

RSX SIZE (TONNAGE RATING)	SCREW CODE	INERTIA				WEIGHT			
		BASE ACTUATOR			PER UNIT	BASE ACTUATOR			PER UNIT
		lb-in ²				lb			
LMI	RP1	RP2	lb-in ² per in	LMI	RP1	RP2	lb per in		
10	BN01	61.10	73.87	31.59	0.33	144.74	160.07	161.92	2.31
10	BN02	61.10	73.87	31.59	0.33	144.74	160.07	161.92	2.31
10	RN12	61.10	73.87	31.59	0.33	144.74	160.07	161.92	2.31
15	BN01	61.10	86.70	34.19	0.33	144.74	161.45	162.63	2.31
15	BN02	61.10	86.70	34.19	0.33	144.74	161.45	162.63	2.31
15	RN12	61.10	86.70	34.19	0.33	144.74	161.45	162.63	2.31
20	RN12	61.10	86.70	34.19	0.33	184.45	205.72	206.90	2.51
25	RN10	242.20	231.29	92.11	0.98	389.38	458.44	462.66	4.40
33*	RN10	*	*	*	*	*	*	*	*
23P*	RN12	61.10	86.70	34.19	0.33	184.45	205.72	206.90	2.51
33P*	RN10	242.20	231.29	92.11	0.98	389.38	458.44	462.66	4.40
		kg-m ² x 10 ⁻⁴			kg-m ² x 10 ⁻⁴ per mm	kg			kg per mm
10	BN01	178.7	216.2	92.4	0.04	65.65	72.61	73.45	0.04
10	BN02	178.7	216.2	92.4	0.04	65.65	72.61	73.45	0.04
10	RN12	178.7	216.2	92.4	0.04	65.65	72.61	73.45	0.04
15	BN01	178.7	253.7	100.5	0.04	65.65	73.23	73.77	0.04
15	BN02	178.7	253.7	100.5	0.04	65.65	73.23	73.77	0.04
15	RN12	178.7	253.7	100.5	0.04	65.65	73.23	73.77	0.04
20	RN12	178.7	253.7	100.5	0.04	83.67	93.31	93.85	0.04
25	RN10	708.8	676.8	269.6	0.11	176.62	207.95	209.86	0.08
33*	RN10	*	*	*	*	*	*	*	*
23P*	RN12	178.7	253.7	100.5	0.04	83.67	93.31	93.85	0.04
33P*	RN10	708.8	676.8	269.6	0.11	176.62	207.95	209.86	0.08

TEMP. RANGE: Standard 4° to 54°C (40° to 130°F). For extended ranges -30°C to 60°C (-22° to 140°F) contact Tolomatic for application review.

RSX Extreme Force, Hydraulic Class Electric Actuator

SIZE: ALL: SCREW BUCKLING LOAD

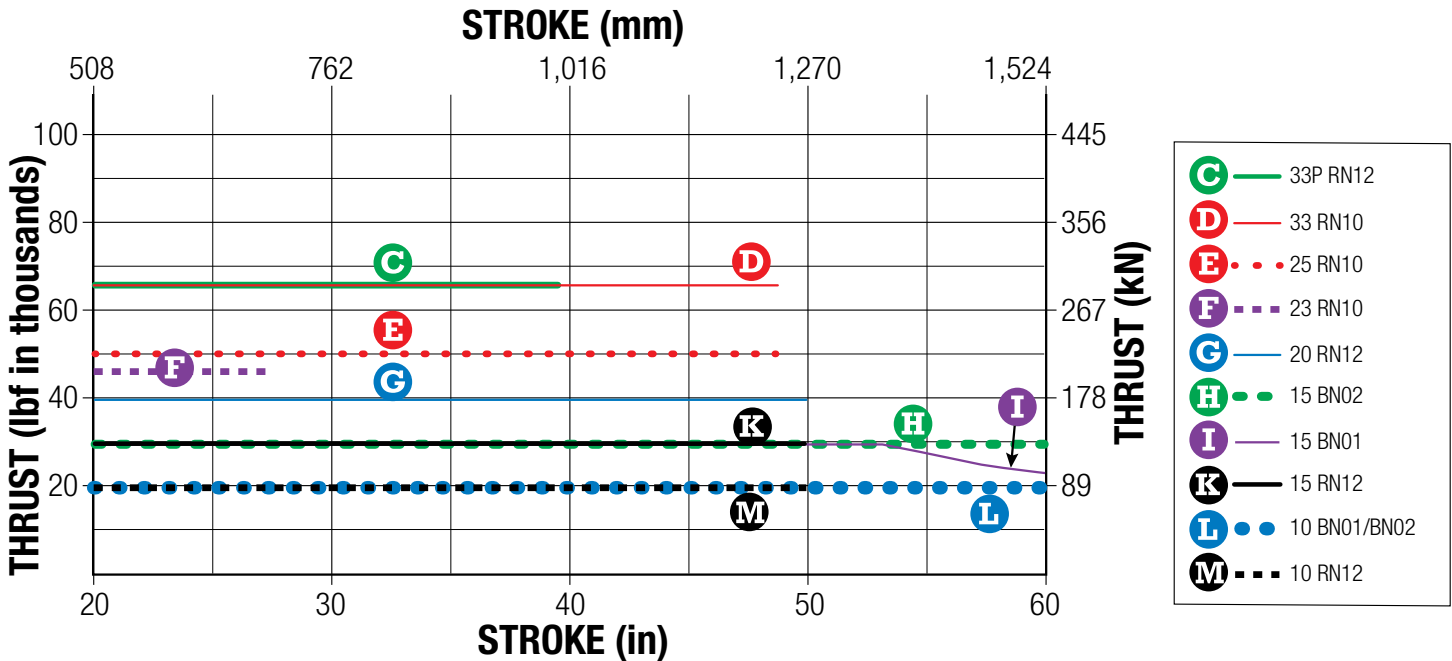

SIZE: ALL: CRITICAL SPEED CAPACITIES

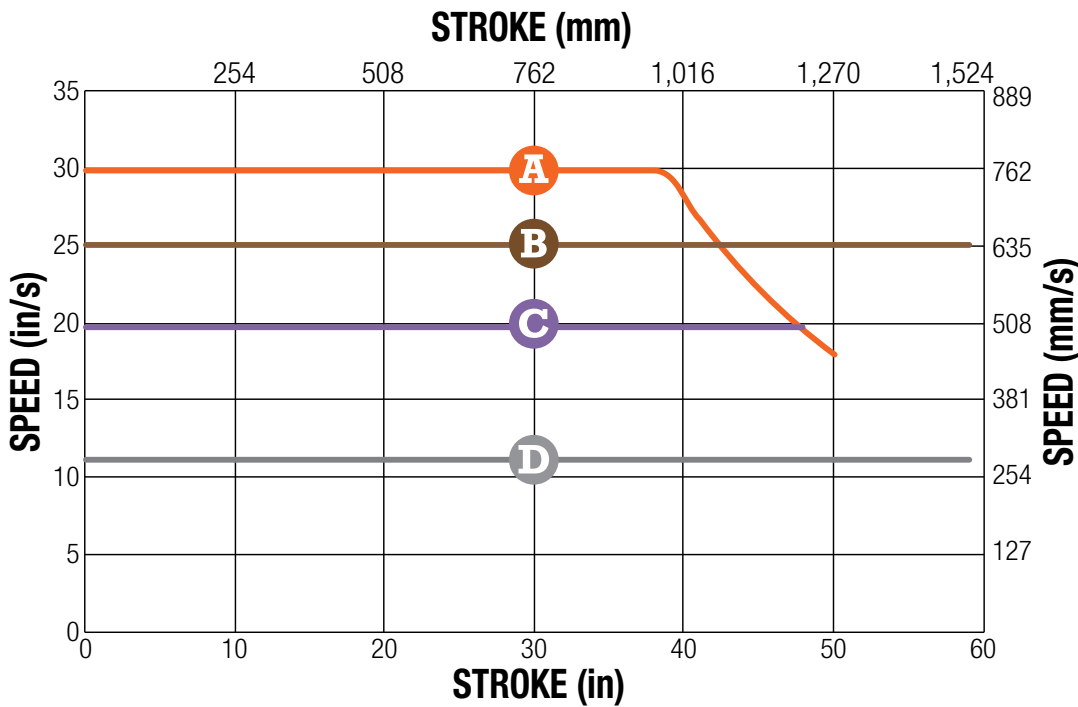

*NOTE: When using Trunnion Mount, (TRR) consider the stroke to be longer when determining Critical Speed and Buckling Load:

STROKE ADDER		
	mm	in
RSX10	72.4	2.85
RSX15	72.4	2.85
RSX20	0.0	0.00
RSX25	108.0	4.25

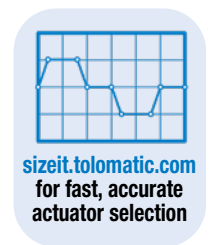

RSX Extreme Force, Hydraulic Class Electric Actuator

SIZE: ALL: EXPECTED LIFE

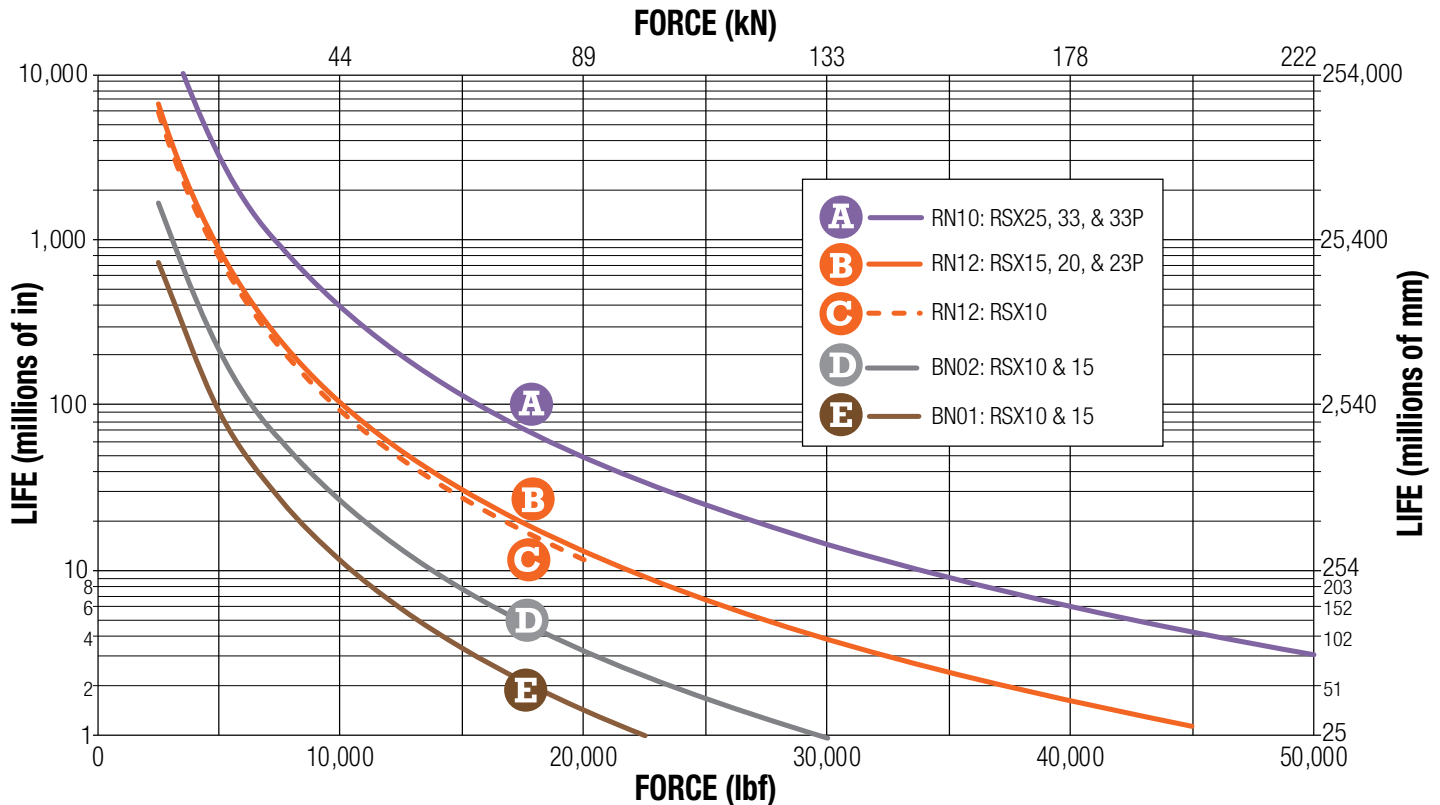

RSX Standard Actuators Expected Life:

NOTE: The L_{10} expected life of a ball or roller screw linear actuator is expressed as the linear travel distance that 90% of properly maintained ball or roller screw manufactured are expected to meet or exceed. This is not a guarantee and this graph should be used for estimation purposes only.

The underlying formula that defines this value is:

$$L_{10} = \left(\frac{C}{P_e} \right)^3 \cdot \ell \equiv$$

L_{10} Travel life in millions of units (in or mm), where:

- C** = Dynamic load rating (lbf) or (N)
- P_e** = Equivalent load (lbf) or (N)
If load is constant across all movements then:
actual load = equivalent load
- ℓ** = Screw lead (in/rev) (mm/rev)

Use the "Equivalent Load" calculation below, when the load is not constant throughout the entire stroke. In cases where there is only minor variation in loading, use greatest load for life calculations.

Where:

$$P_e = \sqrt[3]{\frac{L_1(P_1)^3 + L_2(P_2)^3 + L_3(P_3)^3 + L_n(P_n)^3}{L}}$$

- P_e** = Equivalent load (lbf) or (N)
- P_n** = Each increment at different load (lbf) or (N)
- L** = Total distanced traveled per cycle (extend + retract stroke)
[L = L₁ + L₂ + L₃ + L_n]
- L_n** = Each increment of stroke at different load (in) or (mm)

RSX Press Model Expected Life:

In the event an RSX actuator is used in a press application, calculation of its L10 expected life is modified to consider only the press move, because in press (and similar) applications repeated high force cycles at the same position of the roller screw focus the stress in one area, which may limit the life of the device. For these cases the equivalent load value for the L10 calculation is replaced with the pressing force of the press move only:

The underlying formula that defines this value is:

$$L_{10p} = \left(\frac{C}{P_p} \right)^3 \cdot \ell \equiv$$

L_{10p} Travel life in millions of units (in or mm), where:

- C** = Dynamic load rating (lbf) or (N)
- P_p** = Pressing Force (lbf) or (N)
- ℓ** = Screw lead (in/rev) (mm/rev)

NOTE: The L10 life estimation method does not include failures caused by other conditions such as contamination, misalignment, improper lubrication and exceeding actuator specifications

RSX Extreme Force, Hydraulic Class Electric Actuator



Remove the access cover, and extend or retract the thrust rod for access to the internal grease zerk.

RE-LUBRICATION RECOMMENDATION:

Lubrication requirements for electric actuators depend on the motion cycle (velocity, force, duty cycle), type of application, ambient temperature, environmental surrounding and various other factors.

For many general purpose applications, Tolomatic ball screw actuators are typically considered lubricated for life unless otherwise specified, such as those actuator models outfitted with a re-lubrication feature. For roller screw or ball screw actuators outfitted with a re-lubrication feature, Tolomatic recommends to re-lubricate the actuator at least once per year or every 1,000,000 cycles, whichever comes first, to maximize service life. For more demanding

applications such as pressing, high frequency or other highly stressed applications, the re-lubrication interval for these actuators will vary and will need to be more frequent. In these demanding applications, it is recommended to execute at least 5 full stroke moves every 5,000 cycles of operation (or more frequent if possible) to re-distribute the grease within the actuator.

Re-lubricate with Tolomatic Grease into the grease port located on the side of the actuator.

For OIL Option refer to the RSX Manual, Oil Cooled Option section.

	RSX10, 15, 20, & 23P	RSX25, 33, & 33P
Quantity (g)	$9.5 + (0.025 \times \text{Stroke}^{\text{mm}})$	$12.0 + (0.027 \times \text{Stroke}^{\text{mm}})$
Quantity (oz)	$0.34 + (0.022 \times \text{Stroke}^{\text{in}})$	$0.42 + (0.024 \times \text{Stroke}^{\text{in}})$

Stroke^{mm} = Stroke length in millimeters Strokeⁱⁿ = Stroke length in inches

FOOD GRADE RSX

The food grade RSX is a great option for the food & beverage processing environment.

Contact Tolomatic for lead time and application review.

316 SERIES STAINLESS STEEL

- Tie Rods, Motor Mounting Plate, Thrust Rod, Rod End, Re-Lubrication Port, and Fasteners

FOOD GRADE PAINT

- FDA & USDA approved
- White paint reveals any foreign matter to ease clean-up

IP67 STANDARD

Static tested against ingress of dust and water for protection of internal components and long actuator life

IP67: Ingress Protection: **First Digit** = Solids, 6 = Dust Tight (No ingress of dust; complete protection against contact) **Second Digit** = Liquids, 7 = Immersion up to 1 m (Ingress of water in harmful quantity shall not be possible when the enclosure is immersed in water under defined conditions of pressure and time up to 1 m of submersion)

SMOOTH BODY DESIGN

Fewer collection points for contaminants in wash-down environments

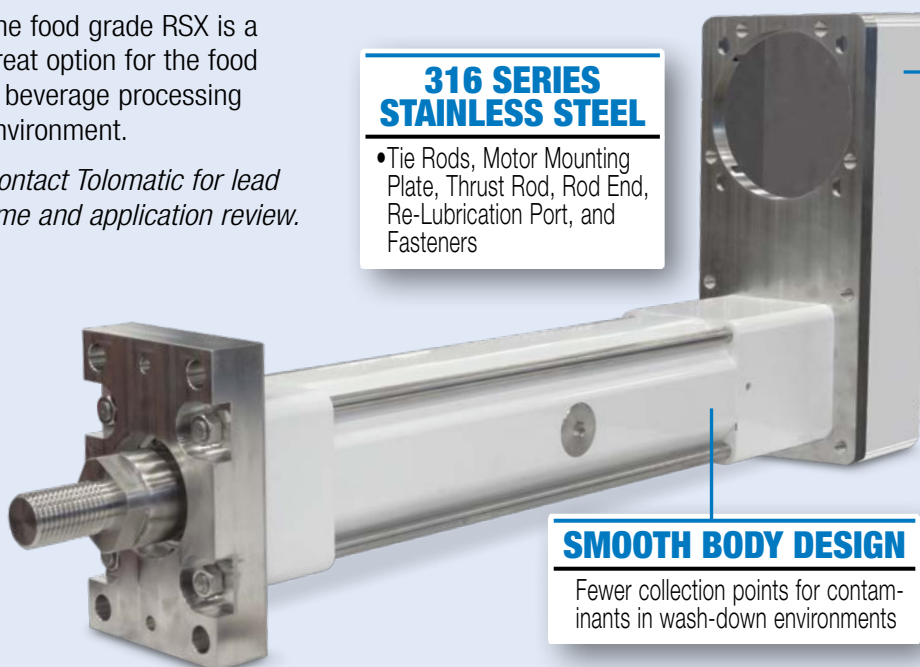
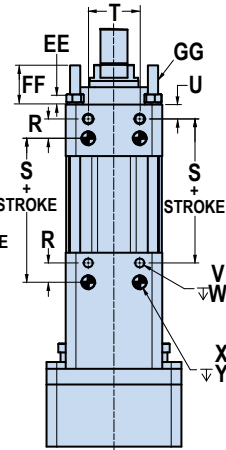
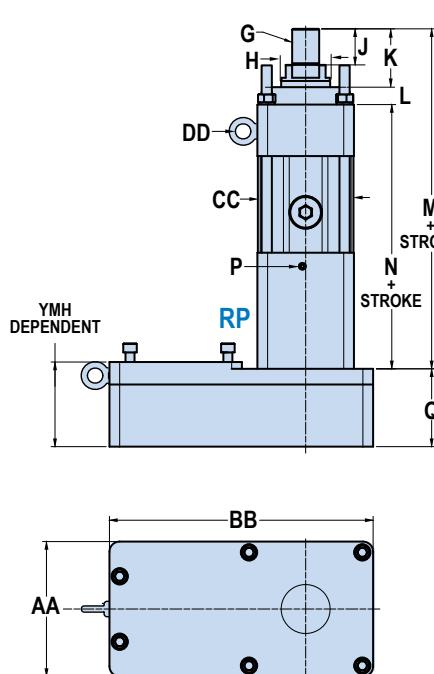
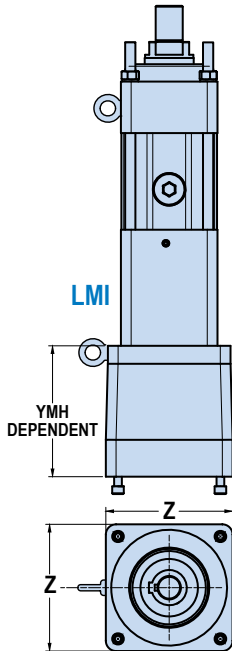
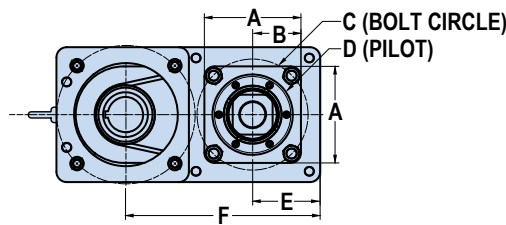

Photo shows non-standard FFGR with RP

RSX Extreme Force, Hydraulic Class Electric Actuator

SIZE: **ALL**

LMI & RP ACTUATOR DIMENSIONS



DIMENSIONS



tolomatic.com/CAD
Download 3D CAD
Always use CAD solid model to determine critical dimensions

NOTE: RSX33 Dimensions available on request

	10 & 15	20 & 23P	25 & 33P
A	150.0	190.5	220.0
B	75.0	95.3	110.0
C	171.0	200.0	250.0
D	125.00 (+0.00) (-0.03)	125.00 (+0.00) (-0.03)	175.0 (+0.00) (-0.03)
E	104.8	104.8	142.9
F	RP1 304.8	304.8	422.9
	RP2 302.3	302.3	424.5
G	M42 x 4.5-6g	M64 x 3.0-6g	M64 x 3.0-6g
H₀	76.093 / 76.149	76.093 / 76.149	101.488 / 101.549
J	69.9	85.1	105.0
K	104.8	114.1	168.2
L1	27.0	27.0	33.0
L2	37.0	37.0	—

L1, M1 = Standard
L2, M2 = Oil Option

	10 & 15		20 & 23P	25 & 33P	
	BN01	BN02	RN	RN	RN
M1	640.6	693.0	588.0	622.3	805.8
M2	650.6	703.0	598.0	632.3	—
N	508.8	561.2	456.2	481.2	604.6
S	335.0	387.4	282.4	289.6	369.0

Dimensions in millimeters

	10 & 15	20 & 23P	25 & 33P
P	RC 1/8 -28 X 38.1 DP (Plugged)	RC 1/4 -19 X 38.1 DP (Plugged)	RC 1/4 -19 X 38.1 DP (Plugged)
Q	138.1	138.1	183.9
R	30.0	40.0	40.0
T	80.0	80.0	115.0
U	22.3	20.0	35.0
V	M16 x 2.0-6H	M20 x 2.5-6H	M20 x 2.5-6H
W	∇ 16.0 (4)	∇ 20.0 (4)	∇ 20.0 (4)
X	20.013/ 20.025	20.013/ 20.038	20.013/ 20.033
Y	∇ 15.0 (4)	∇ 15.0 (4)	∇ 30.0 (4)
Z	190.5	190.5	285.8
AA	209.6	209.6	291.1
BB	425.5	425.5	584.2
CC	148.6	148.6	215.0
DD	25.0	35.0	35.0
EE	15.3	23.0	23.0
FF	54.2	72.1	76.2
GG	M16 x 1.5-6H	M24 x 3.0-6H	M24 x 3.0-6H

Dimensions in millimeters

	10 & 15	20 & 23P	25 & 33P
A	5.91	7.50	8.66
B	2.95	3.75	4.33
C	6.73	7.87	9.84
D	4.921 (+0.000) (-0.001)	4.921 (+0.000) (-0.001)	6.89 (+0.000) (-0.001)
E	4.13	4.13	5.63
F	RP1 12.00	12.00	16.65
	RP2 11.90	11.90	16.71
G	1 7/8-12 UN-2A	2 1/2-12 UN-2A	2 1/2-8 UN-2A
H₀	2.9958/ 2.9980	2.9958/ 2.9980	3.9956/ 3.9980
J	2.75	3.35	4.13
K	4.13	4.49	6.62
L1	1.06	1.06	1.30
L2	1.46	1.46	—

L1, M1 = Standard
L2, M2 = Oil Option

	10 & 15		20 & 23P	25 & 33P	
	BN01	BN02	RN	RN	RN
M1	25.22	27.28	23.15	24.50	31.72
M2	25.61	27.68	23.54	24.89	—
N	20.03	22.09	17.96	18.94	23.80
S	13.19	15.25	11.12	11.40	14.53

Dimensions in inches

RSX Extreme Force, Hydraulic Class Electric Actuator

SIZE: ALL

DIMENSIONS

CLEVIS OPTION (CLV)

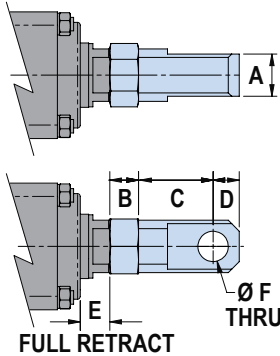

	10 & 15	20 & 23P	25 & 33P
A	50.00/ 49.59	60.00/ 59.26	60.00/ 59.26
B	34.0	51.0	51.0
C	88.3	137.0	137.0
D	31.0	45.0	45.0
E	35.0	30.7	63.2
F	36.06/ 36.00	45.06/ 45.00	45.06/ 45.00

Dimensions in millimeters

	10 & 15	20 & 23P	25 & 33P
A	1.575/ 1.559	2.362/ 2.333	2.362/ 2.333
B	1.34	2.01	2.01
C	2.95	3.48	5.39
D	1.22	1.77	1.77
E	1.38	1.21	2.49
F	1.420/ 1.417	1.774/ 1.772	1.774/ 1.772

Dimensions in inches



tolomatic.com/CAD
Download 3D CAD
Always use CAD solid
model to determine
critical dimensions

FRONT FLANGE OPTION (FFG)

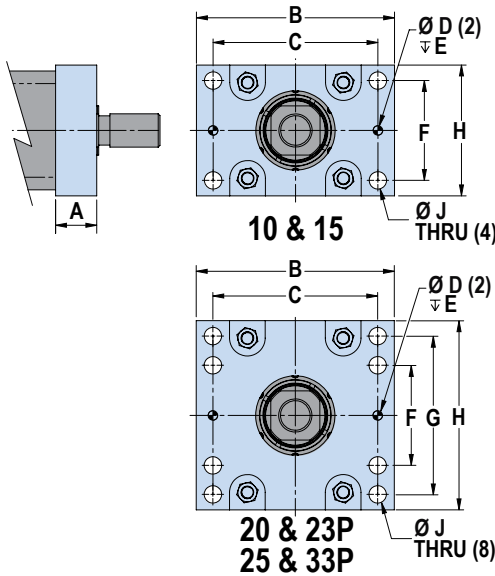

Size	FFG weight adder
10 & 15	26 lb (12 kg)
20 & 23P	54 lb (24 kg)
25 & 33P	82 lb (37 kg)

	10 & 15	20 & 23P	25 & 33P
A	62.0	86.0	85.0
B	250.0	300.0	360.0
C	208.0	255.0	300.0
D	12.025/ 12.013	16.030/ 16.000	20.033/ 20.013
E	12.0	16.0	20.0
F	126.0	55.0	65.0
G	—	165.0	190.0
H	165.0	210.0	245.0
J	22.0	22.0	26.2

Dimensions in millimeters

	10 & 15	20 & 23P	25 & 33P
A	2.44	2.99	3.35
B	9.84	11.81	14.17
C	8.19	10.04	11.81
D	0.4734/ 0.4729	0.6310/ 0.6300	0.7887/ 0.7879
E	0.47	0.63	0.79
F	4.96	2.17	2.56
G	—	6.50	7.48
H	6.50	8.27	9.65
J	0.87	0.87	1.03

Dimensions in inches

EXTENDED TIE ROD OPTION (XT)

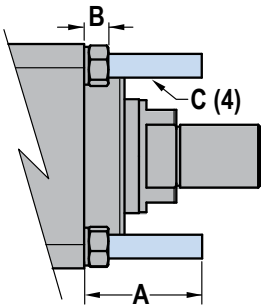

		10 & 15	20 & 23P	25 & 33P
A	MIN	mm 50.0	50.0	50.0
		in 1.97	1.97	1.97
A	MAX	mm 100.0	100.0	100.0
		in 3.94	3.94	3.94
B		mm 16.3	23.0	23.0
		in 0.60	0.91	0.91
C (4)		M16 x 1.5-6g	M24 x 3.0-6g	M24 x 3.0-6g

A = Customer Specified Length

RSX Extreme Force, Hydraulic Class Electric Actuator

SIZE: ALL

DIMENSIONS

MOUNTING PLATE OPTION (MP2) DIMENSIONS

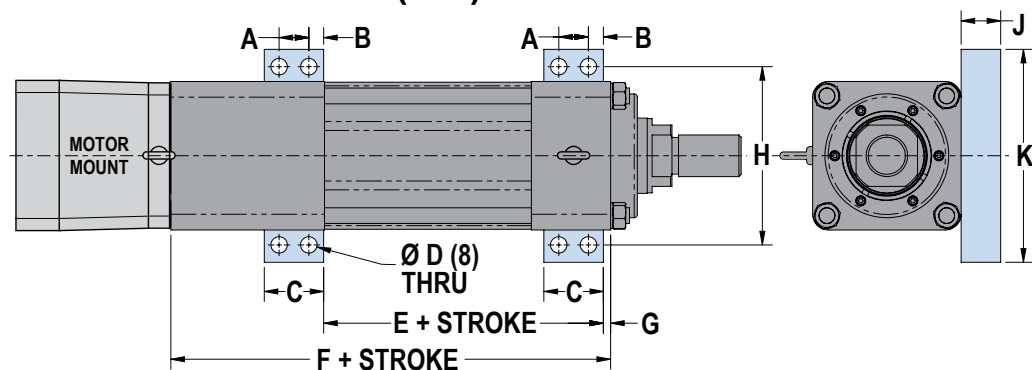

tolomatic.com/CAD
Download 3D CAD
Always use CAD solid model to determine critical dimensions

	10 & 15	20 & 23P	25 & 33P
A	30.0	40.0	40.0
B	15.0	19.0	22.5
C	60.0	78.0	85.0
D	16.7	21.0	21.0
RN	282.4	288.9	369.0
E BN01	335.0	-	-
BN02	387.4	-	-

	10 & 15	20 & 23P	25 & 33P
RN	352.7	481.2	604.6
F BN01	508.8	-	-
BN02	561.2	-	-
G	7.3	1.0	12.5
H	180.0	230.0	260.0
J	40.0	45.0	45.0
K	215.0	270.0	305.0

Dimensions in millimeters

	10 & 15	20 & 23P	25 & 33P
A	1.18	1.57	1.57
B	0.59	0.79	0.89
C	2.36	3.07	3.35
D	0.66	0.83	0.83
RN	11.12	11.37	14.53
E BN01	13.19	-	-
BN02	15.25	-	-

	10 & 15	20 & 23P	25 & 33P
RN	13.89	18.94	23.80
F BN01	20.03	-	-
BN02	22.09	-	-
G	0.29	0.04	0.49
H	7.09	9.06	10.24
J	1.57	1.77	1.77
K	8.46	10.60	12.01

Dimensions in inches

TRUNNION OPTION (TRR) DIMENSIONS

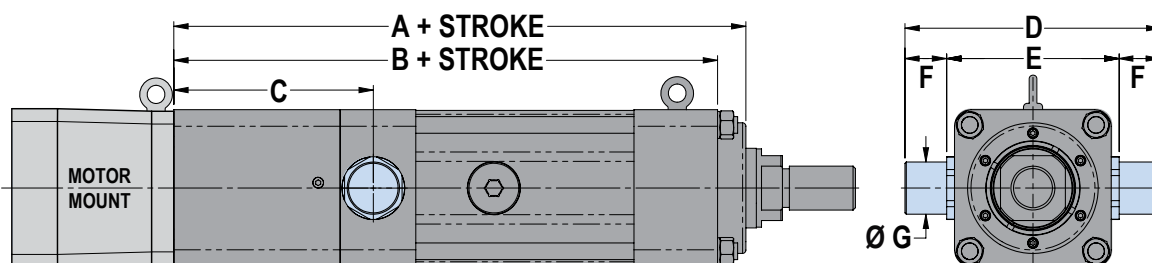

NOTE: TRR option reduces max stroke:
RSX10 & 15 sizes by 3.3in (84mm)
RSX25 size by 4.3in (109mm)

	10 & 15	20 & 23P	25 & 33P
RN	556.5	509.2	750.8
A BN01	608.2	-	-
BN02	660.6	-	-
RN	529.5	482.1	713.7
B BN01	581.2	-	-
BN02	633.6	-	-

	10 & 15	20 & 23P	25 & 33P
C	199.9	76.0	268.1
D	245.0	364.2	340.0
E	165.0	264.2	240.0
F	40.0	50.0	50.0
G	49.98/ 49.94	59.97/ 59.92	62.97/ 62.92

Dimensions in millimeters

	10 & 15	20 & 23P	25 & 33P
RN	21.91	20.05	29.56
A BN01	23.94	-	-
BN02	26.00	-	-
RN	20.85	19.00	28.10
B BN01	22.88	-	-
BN02	24.90	-	-

	10 & 15	20 & 23P	25 & 33P
C	7.87	2.90	10.56
D	9.65	14.34	13.39
E	6.50	10.40	9.45
F	1.57	1.97	1.97
G	1.968/ 1.966	2.361/ 2.359	2.479/ 2.477

Dimensions in inches

OPTIONAL ROD EXTENSION (XR)

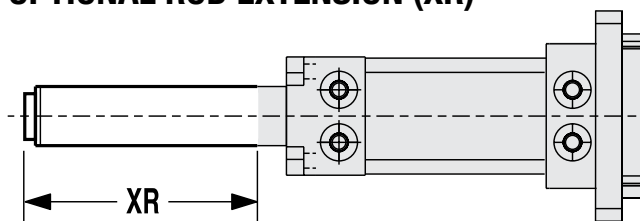

The thrust rod length can be extended by specifying the rod extension option. This does not increase the working stroke, only the length of the thrust rod.

NOTE: Please consult Tolomatic if your application requires rod extension length greater than 100 mm (3.9 in).

RSX Extreme Force, Hydraulic Class Electric Actuator

SWITCHES



RSX actuators offer a wide range of sensing choices. There are 12 switch choices: reed, solid state PNP (sourcing) or solid state NPN (sinking); in normally open or normally closed; with flying leads or quick-disconnect.

Commonly used for end-of-stroke positioning, these switches allow installation anywhere along the entire actuator length. The internal magnet is a standard feature. Switches can be installed in the field at any time.

Switches are used to send digital signals to PLC (programmable logic controller), TTL, CMOS circuit or other controller device. Switches contain reverse polarity protection. Solid state QD cables are shielded; shield should be terminated at flying lead end.

All switches are CE rated and are RoHS compliant. Switches feature bright red or yellow LED signal indicators; solid state switches also have green LED power indicators.



	Order Code	Lead	Switching Logic	Power LED	Signal LED	Operating Voltage	**Power Rating (Watts)	Switching Current (mA max.)	Current Consumption	Voltage Drop	Leakage Current	Temp. Range	Shock / Vibration
REED	R Y	5m	SPST Normally Open	—	Red	5 - 240 AC/DC	**10.0	100mA	—	3.0 V max.	—	14 to 158°F [-10 to 70°C]	50 G / 9 G
	R K	QD*											
	N Y	5m	SPST Normally Closed	—	Yellow	5 - 110 AC/DC							
	N K	QD*											
SOLID STATE	T Y	5m	PNP (Sourcing) Normally Open	Green	Yellow	10 - 30 VDC	**3.0	100mA	20 mA @ 24V	2.0 V max.	0.05 mA max.		
	T K	QD*											
	K Y	5m	NPN (Sinking) Normally Open	Green	Red								
	K K	QD*											
	P Y	5m	PNP (Sourcing) Normally Closed	Green	Yellow								
	P K	QD*											
	H Y	5m	NPN (Sinking) Normally Closed	Green	Red								
	H K	QD*											

*QD = Quick-disconnect

Enclosure classification IEC 529 IP67 (NEMA 6)

CABLES: Robotic grade, oil resistant polyurethane jacket, PVC insulation

⚠️ **WARNING: Do not exceed power rating (Watt = Voltage x Amperage). Permanent damage to sensor will occur.

SWITCH INSTALLATION



Place switch bracket onto any one of the four tie rods that run the length of the extruded tube. Insert the switch with set screw and the word "Tolomatic" facing up and slide into the mating slot on the bracket. Position the bracket with the switch to the exact location desired, with the bracket tight to the surface of the extrusion, then lock the bracket securely into place by tightening the set screw with the Allen wrench provided. Then tighten the switch into the bracket with a small slotted screwdriver.

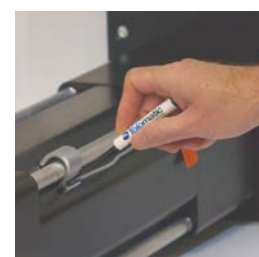

RSX Extreme Force, Hydraulic Class Electric Actuator

SWITCHES

WIRING DIAGRAMS

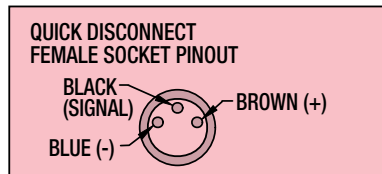
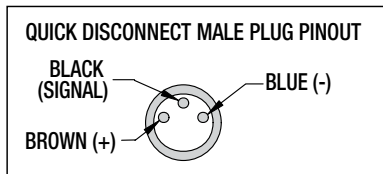
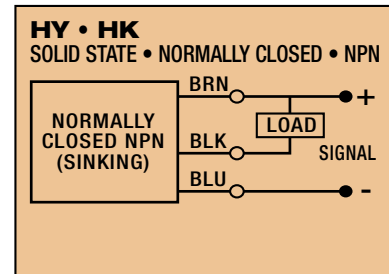
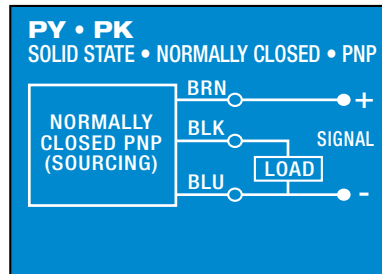
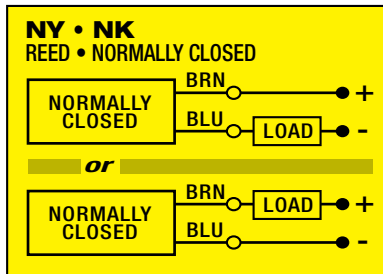
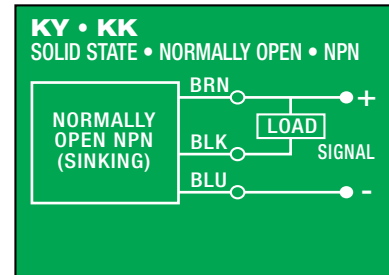
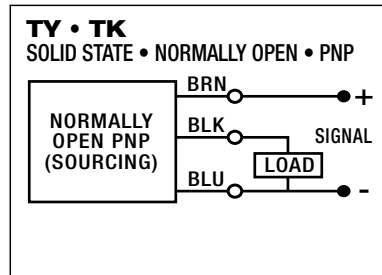
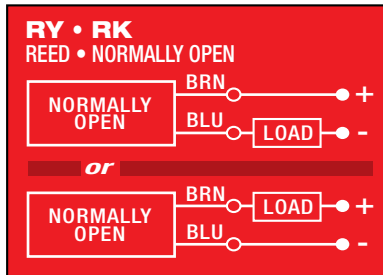

SWITCH DIMENSIONS

- direct connect

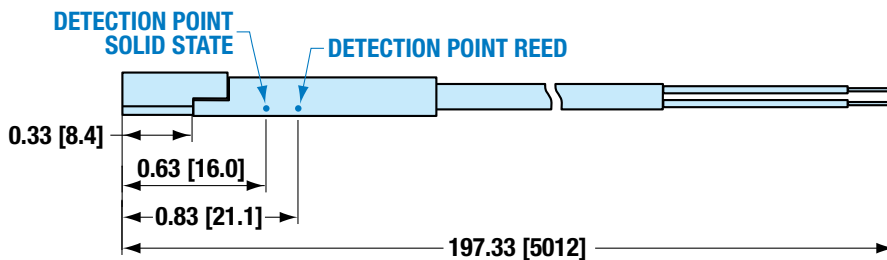

- QD (Quick-disconnect) switch

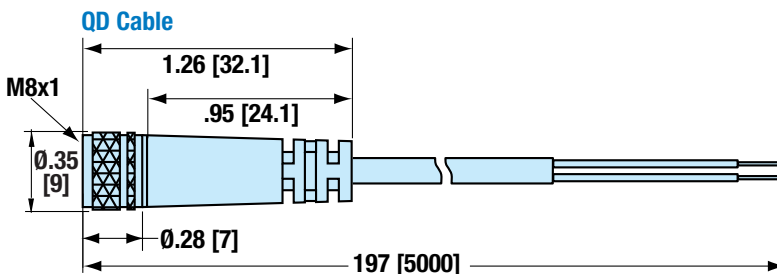
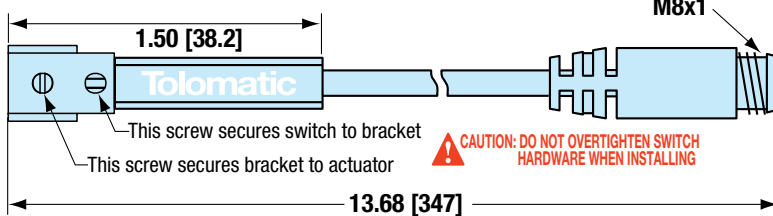

SWITCH MOUNTING

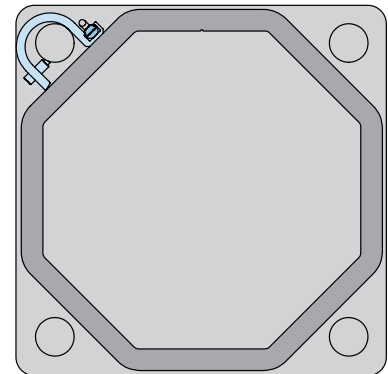

The switch bracket and switch does not extend beyond the profile of the RSX heads.

RSX Extreme Force, Hydraulic Class Electric Actuator

Application Data Worksheet

USE THE TOLOMATIC SIZING AND SELECTION SOFTWARE AVAILABLE ON-LINE AT www.tolomatic.com or call Tolomatic at 1-800-328-2174. We will provide any assistance needed to determine the proper actuator for the job.

ACTUATOR ORIENTATION

- Horizontal
 Vertical-Motor End Up
 Angled
 Vertical-Motor End Down

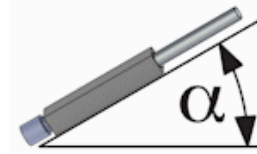

Angle: _____ degrees

ACTUATOR REQUIREMENTS

- Stroke Length:** _____ inches millimeters
No. of Cycles: _____ per minute per hour
Actuator to Hold Position: required not required
If Hold Required: after move during power loss
Motor: Third Party Motor Tolomatic Motor

APPLICATION ENVIRONMENT

- Ambient Temperature:** _____ °F °C
 Actuator Environment Description and Ingress Protection Requirements:

MOTION & FORCES

Extend

- Move Distance: _____ in mm
 Move Time: _____ seconds
 Max. Speed: _____ in/s mm/s
 Dwell Time After Move: _____ seconds

Load

- Load:** _____ lb kg
Supported by Actuator: _____ %
Moment Prevention: Guided/Supported
Center of Load:
D_x: _____ in mm
D_y: _____ in mm
D_z: _____ in mm
Assign to Moves: Extend Retract

Retract

- Move Distance: _____ in mm
 Move Time: _____ seconds
 Max. Speed: _____ in/s mm/s
 Dwell Time After Move: _____ seconds

Force

- Force:** _____ lbf N
Force Direction: Toward Away
Direction of Applied Force: F_x F_y F_z
Center of Applied Force:
D_x: _____ in mm
D_y: _____ in mm
D_z: _____ in mm
Assign to Moves: Extend Retract

RSX Extreme Force, Hydraulic Class Electric Actuator

Selection Guidelines

1 ESTABLISH MOTION PROFILE

Using the application stroke length, desired cycle time, loads and forces, establish the motion profile details including linear velocity and force in each of its segments.

2 SELECT ACTUATOR SIZE AND SCREW TYPE

Based on the required velocities and forces, select an actuator size including the lead of the roller screw assembly.

3 VERIFY CRITICAL SPEED OF THE SCREW

Verify that the application's peak linear velocity does not exceed the critical speed value for the size and lead of the screw selected.

4 VERIFY AXIAL BUCKLING STRENGTH OF THE SCREW

Verify that the peak force does not exceed the critical buckling force for the size of the screw selected.

5 COMPARE APPLICATION'S PEAK PARAMETERS TO PEAK CAPACITY (PEAK REGION) OF SELECTED ACTUATOR

Calculate the application's required peak force and peak velocity and compare to the graphs. The selection must satisfy the application's peak requirements.

6 CONSIDER THERMAL MITIGATION

Determine whether the oil cooled option is necessary based on the calculated screw thermals in the application.

7 CONSIDER LUBRICATION INTERVAL

Evaluate the recommended lubrication interval with respect to the application motion profile.

See page RSX_11 for complete lubrication information.



The above guidelines are for reference only. Use Tolomatic online sizing software for best results.

8 TEMPERATURE CONSIDERATIONS

If the application's ambient temperature lies outside of the standard range (see page RSX_8), contact Tolomatic.

9 SELECT A MOTOR-ACTUATOR CONFIGURATION

Select an inline or a reverse-parallel motor configuration.

10 ESTABLISH TOTAL TORQUE REQUIREMENTS

Calculate total system inertia, the peak and the RMS torque required from the motor to overcome internal friction, external forces and accelerate/decelerate the load.

11 SELECT A MOTOR

Use the obtained total torque value to select a motor and a reduction device (if required). Verify that the peak torque value is below the motor's peak torque curve, and that the continuous torque value is below the motor's continuous torque curve. Verify the minimum torque margin (15%). Verify the inertia match.

12 SELECT OPTIONAL POSITION SENSORS

12 sensor choices include: reed, solid state PNP or NPN, all in normally open or normally closed, with flying leads or quick-disconnect couplers.

13 SELECT ACTUATOR MOUNTING

Mounting options include: TRN trunnion mount, FFG front flange mount, MP2 mounting plates.

14 SELECT ROD END OPTIONS

Rod end options include: CLV clevis rod end.

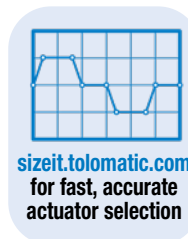

RSX Extreme Force, Hydraulic Class Electric Actuator

Ordering

ACTUATOR										OPTIONS																																																																							
RSX	15	RN12	SM450	RP1	HT1	FFG	OIL	CLV	XR10	KK2	YM																																																																						
MODEL & MOUNTING					MOTOR MOUNTING					ROD END																																																																							
RSX Rod-Style Actuator					LMI In-line motor mount RP1 1:1 ratio, reverse parallel motor mount RP2 2:1 ratio, reverse parallel motor mount					Externally threaded rod end is standard CLV Clevis Rod End SR1 Imperial Thread																																																																							
SIZE (TONNAGE RATING)					STANDARD OR HIGH TORQUE					ROD EXTENSION																																																																							
10, 15, 20, 25, 33†					ST1* Standard Actuator HT1 High Torque Option					XR___ Enter desired rod extension in millimeters																																																																							
23P†, 33P† Press Models					*Only available with RP option on RSX10					NOTE: XR option does not increase the working stroke, only the length of the thrust rod.																																																																							
†Contact Tolomatic for ordering										NOTE: Please consult Tolomatic if your application requires rod extension length greater than 100 mm (3.9 in).																																																																							
NUT/SCREW					TRUNNION MOUNT					SWITCHES																																																																							
<table border="1"> <thead> <tr> <th>SIZE</th> <th>CODES</th> </tr> </thead> <tbody> <tr> <td>10</td> <td>RN12, BN01, BN02</td> </tr> <tr> <td>15</td> <td>RN12, BN01, BN02</td> </tr> <tr> <td>20</td> <td>RN12</td> </tr> <tr> <td>23P†</td> <td>RN12</td> </tr> <tr> <td>25</td> <td>RN10</td> </tr> <tr> <td>33†</td> <td>RN10</td> </tr> <tr> <td>33P†</td> <td>RN10</td> </tr> </tbody> </table>					SIZE	CODES	10	RN12, BN01, BN02	15	RN12, BN01, BN02	20	RN12	23P†	RN12	25	RN10	33†	RN10	33P†	RN10	TRR Trunnion mount					<table border="1"> <thead> <tr> <th>TYPE</th> <th>LOGIC</th> <th>NORMALLY</th> <th>QUICK-DISCONNECT</th> <th>CODE</th> <th>QUANTITY</th> <th>LEAD LENGTH</th> </tr> </thead> <tbody> <tr> <td rowspan="2">REED</td> <td rowspan="2">SPST</td> <td>Open</td> <td>no</td> <td>RY</td> <td rowspan="10">After code enter quantity desired</td> <td rowspan="10">5 meters (16.4 feet)</td> </tr> <tr> <td>Closed</td> <td>yes</td> <td>NK</td> </tr> <tr> <td rowspan="6">SOLID STATE</td> <td rowspan="2">PNP</td> <td>Open</td> <td>no</td> <td>TY</td> </tr> <tr> <td>Closed</td> <td>yes</td> <td>TK</td> </tr> <tr> <td rowspan="2">NPN</td> <td>Open</td> <td>no</td> <td>KY</td> </tr> <tr> <td>Closed</td> <td>yes</td> <td>KK</td> </tr> <tr> <td rowspan="2">PNP</td> <td>Open</td> <td>no</td> <td>PY</td> </tr> <tr> <td>Closed</td> <td>yes</td> <td>PK</td> </tr> <tr> <td rowspan="2">NPN</td> <td>Open</td> <td>no</td> <td>HY</td> </tr> <tr> <td>Closed</td> <td>yes</td> <td>HK</td> </tr> </tbody> </table>					TYPE	LOGIC	NORMALLY	QUICK-DISCONNECT	CODE	QUANTITY	LEAD LENGTH	REED	SPST	Open	no	RY	After code enter quantity desired	5 meters (16.4 feet)	Closed	yes	NK	SOLID STATE	PNP	Open	no	TY	Closed	yes	TK	NPN	Open	no	KY	Closed	yes	KK	PNP	Open	no	PY	Closed	yes	PK	NPN	Open	no	HY	Closed	yes	HK					
SIZE	CODES																																																																																
10	RN12, BN01, BN02																																																																																
15	RN12, BN01, BN02																																																																																
20	RN12																																																																																
23P†	RN12																																																																																
25	RN10																																																																																
33†	RN10																																																																																
33P†	RN10																																																																																
TYPE	LOGIC	NORMALLY	QUICK-DISCONNECT	CODE	QUANTITY	LEAD LENGTH																																																																											
REED	SPST	Open	no	RY	After code enter quantity desired	5 meters (16.4 feet)																																																																											
		Closed	yes	NK																																																																													
SOLID STATE	PNP	Open	no	TY																																																																													
		Closed	yes	TK																																																																													
	NPN	Open	no	KY																																																																													
		Closed	yes	KK																																																																													
	PNP	Open	no	PY																																																																													
		Closed	yes	PK																																																																													
NPN	Open	no	HY																																																																														
	Closed	yes	HK																																																																														
RN = Roller Nut/Screw BN = Ball Nut/Screw †Contact Tolomatic for ordering					*Only available with RP option on RSX10 NOTE: Trunnion mount is not available for field retrofit, contact Tolomatic for details																																																																												
STROKE LENGTH					IP67					YOUR MOTOR HERE																																																																							
SM___ Enter desired stroke length in millimeters					IP67 Ingress protection and thrust rod scraper					YM_____ Motor mount for non-Tolomatic motor.																																																																							
See page 8 for minimum and maximum stroke lengths available					ACTUATOR MOUNTING For all motor mounts: FFG Front Flange Mount MP2 Mounting Plates (2 required) XT Extended Tie Rods (min. 50mm, max. 100mm)					www.tolomatic.com																																																																							
					OIL COOLED																																																																												
					OIL For extended high duty cycle/high force performance																																																																												
					NOTE: The RSX actuator with oil cooled option is IP67 rated. To get a motor gasket select IP67 option																																																																												



Photo shows non-standard FFG with RP



Not all codes listed are compatible with all options. Contact Tolomatic with any questions.

NOTE: Brakes mounted on reverse parallel motor mounts (especially in vertically positioned actuators) will not prevent back driving of the screw and the load falling under gravity in the event of a timing belt failure. An inline motor mount with a fail-safe brake mounted directly to the actuator shaft or a special geared or thru-shaft reverse parallel construction should be considered if a brake is required in a safety critical application. Contact Tolomatic for alternate reverse parallel brake mounting options.

The Tolomatic Difference Expect More From the Industry Leader:



INNOVATIVE PRODUCTS

Solutions with Endurance TechnologySM for challenging applications.



FAST DELIVERY

Built-to-order with configurable stroke lengths and flexible mounting options.

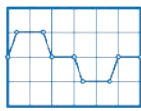

ACTUATOR SIZING

Size and select electric actuators with our online software.



YOUR MOTOR HERE[®]

Match your motor to compatible mounting plates with Tolomatic actuators.



CAD LIBRARY

Download 2D or 3D CAD files for Tolomatic products.



TECHNICAL SUPPORT

Get a question answered or request a virtual design consultation with one of our engineers.

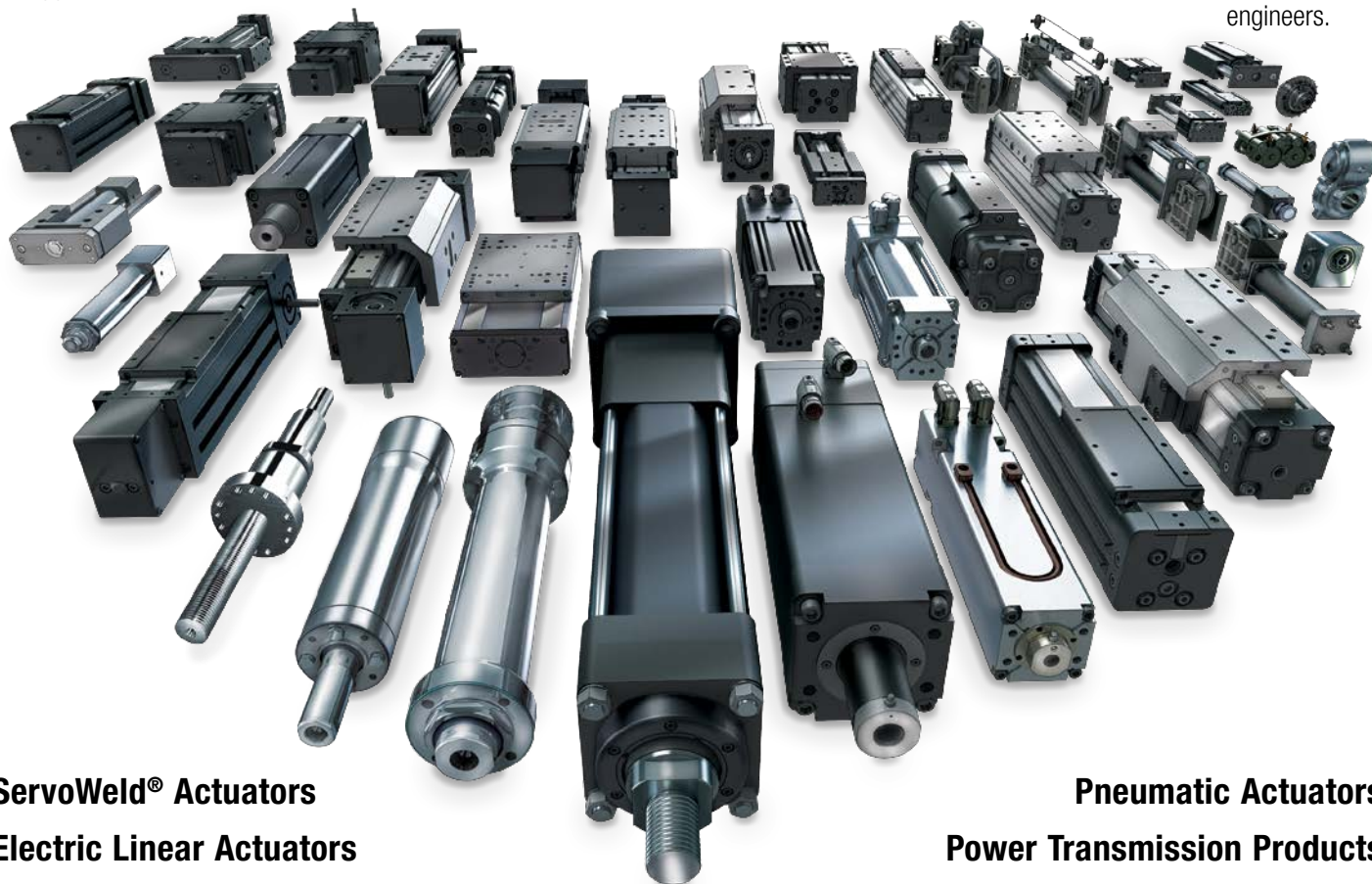

ServoWeld[®] Actuators
Electric Linear Actuators

Pneumatic Actuators
Power Transmission Products



MADE IN U.S.A.

Tolomatic[™]

EXCELLENCE *IN* MOTION

COMPANY WITH
QUALITY SYSTEM
CERTIFIED BY DNV
= ISO 9001 =
Certified site: Hamel, MN

USA - Headquarters

Tolomatic Inc.

3800 County Road 116
Hamel, MN 55340, USA

Phone: (763) 478-8000

Toll-Free: **1-800-328-2174**

sales@tolomatic.com

www.tolomatic.com

MEXICO

Centro de Servicio

Parque Tecnológico Innovación
Int. 23, Lateral Estatal 431,
Santiago de Querétaro,
El Marqués, México, C.P. 76246

Phone: +1 (763) 478-8000

help@tolomatic.com

EUROPE

Tolomatic Europe GmbH

Elisabethenstr. 20
65428 Rüsselsheim
Germany

Phone: +49 6142 17604-0

help@tolomatic.eu

www.tolomatic.com/de-de

CHINA

Tolomatic Automation Products (Suzhou) Co. Ltd.

No. 60 Chuangye Street, Building 2
Huqiu District, SND Suzhou
Jiangsu 215011 - P.R. China

Phone: +86 (512) 6750-8506

Tolomatic_China@tolomatic.com

All brand and product names are trademarks or registered trademarks of their respective owners. Information in this document is believed accurate at time of printing. However, Tolomatic assumes no responsibility for its use or for any errors

that may appear in this document. Tolomatic reserves the right to change the design or operation of the equipment described herein and any associated motion products without notice. Information in this document is subject to change without notice.

Visit www.tolomatic.com for the most up-to-date technical information