

**ENDURANCE TECHNOLOGY**<sup>SM</sup>

# ERD ELECTRIC ROD-STYLE ACTUATOR

PATENT PENDING

NOTE: ERD22, ERD25,  
ERD30 are replaced  
by the improved  
design of the RSH22,  
RSH25, RSH30





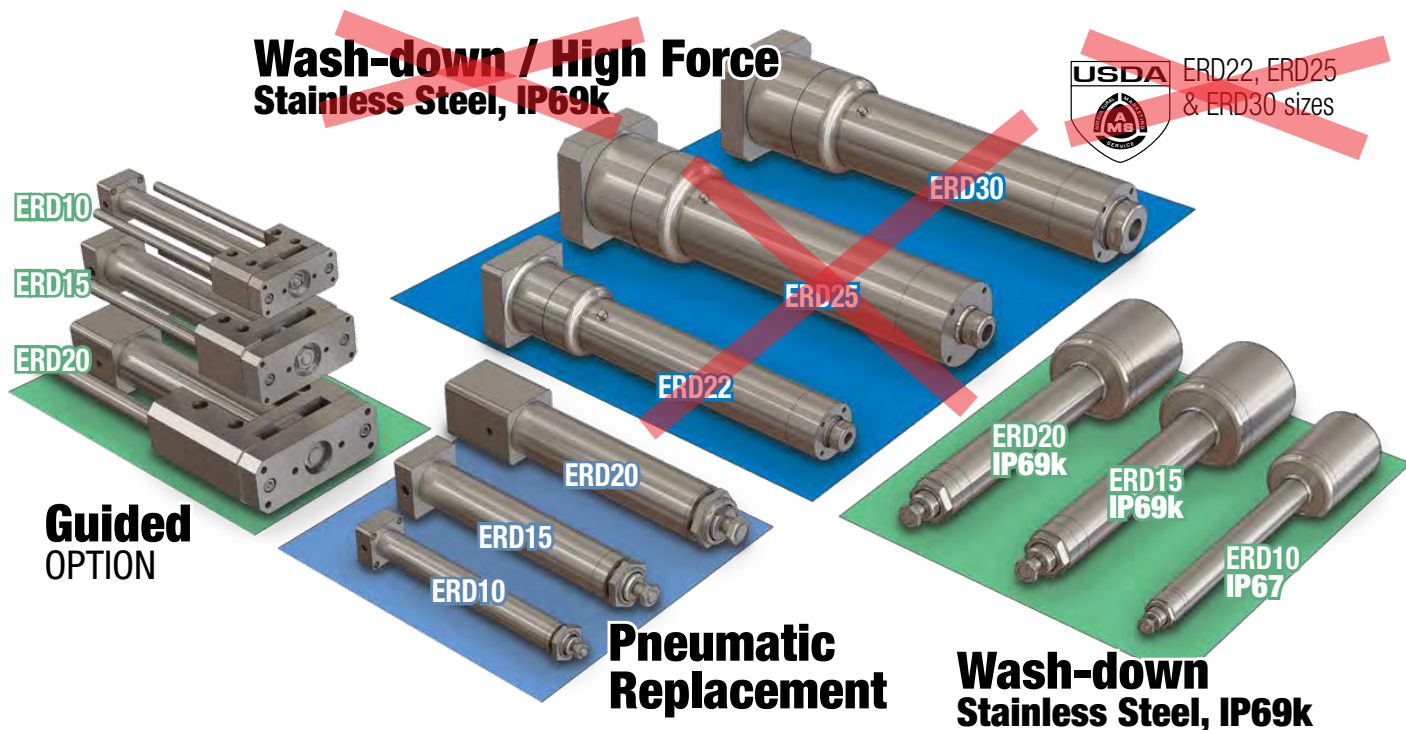

# ERD – Electric Rod-Style Actuator

The ERD is an economical rod-style electric actuator designed as an alternative to pneumatic cylinders, a cost effective actuator for general automation and an option for automating manual processes. In addition, the ERD is available with all stainless steel and IP69K options which makes it the ideal hygienic actuator for the food & beverage processing environment.



## TOLOMATIC'S ELECTRIC ROD-STYLE ACTUATORS

**NOTE: ERD22, ERD25, ERD30 are replaced by the improved design of the RSH22, RSH25, RSH30**

	ERD	RSA	RSX	GSA	IMA
					
	Rod-Style Actuator	Rod-Style Actuator	Rod-Style Actuator	Guided Rod-Style Actuator	Integrated Servo Actuator
<b>Force</b> up to:	<del>35 kN (7,868 lbf)</del>	58 kN (13,039 lbf)	222.4 kN (50,000 lbf)	4.23 kN (950 lbf)	30.6 kN (6,875 lbf)
<b>Speed</b> up to:	1473 mm/sec (58 in/sec)	3,124 mm/sec (123 in/sec)	760 mm/sec (29.9 in/sec)	3,124 mm/sec (123 in/sec)	1,334 mm/sec (52.5 in/sec)
<b>Stroke Length</b> up to:	<del>1000 mm (39.4 in)</del>	1,524 mm (60 in)	890 mm (35 in)	914 mm (36 in)	457 mm (18 in)
<b>Screw/Nut Type</b>	Solid, Ball & Roller	Solid, Ball & Roller	Roller	Solid & Ball	Ball & Roller
<i>For complete information see <a href="http://www.tolomatic.com">www.tolomatic.com</a> or literature number:</i>					
<b>Literature Number:</b>	2190-4000	3600-4166	2171-4001	3600-4166	2700-4000

(Not all models deliver maximum values listed, i.e.: Maximum thrust may not be available with maximum speed)



# ERD – Applications

## Filling, Pumping



## Chopping, Press Fit, Pick & Place, Assembly

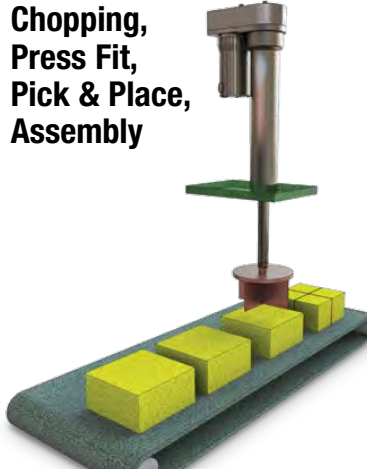

## Gating, Sorting, Diverting

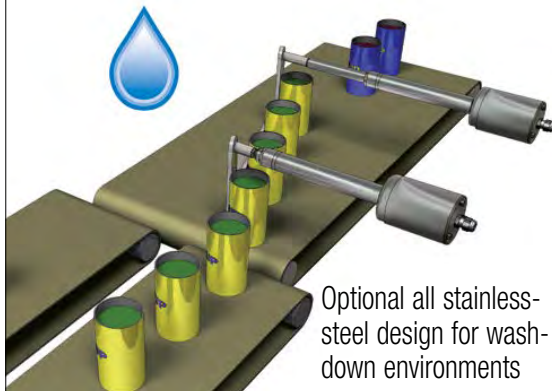

## Aligning

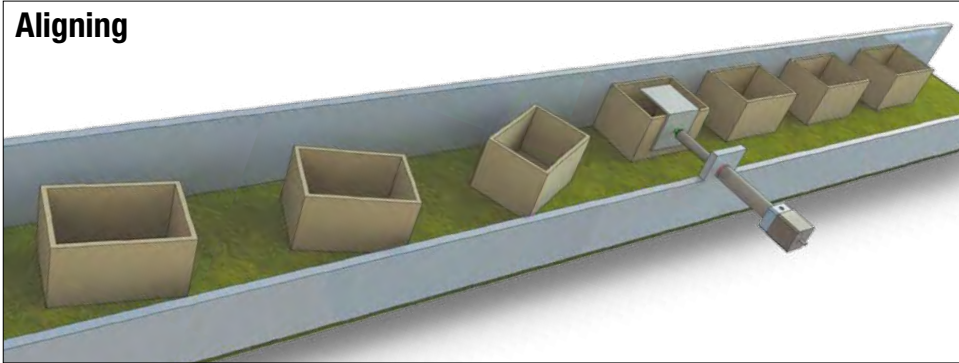

## Product Change Over



## Heat Staking, Sonic Welding

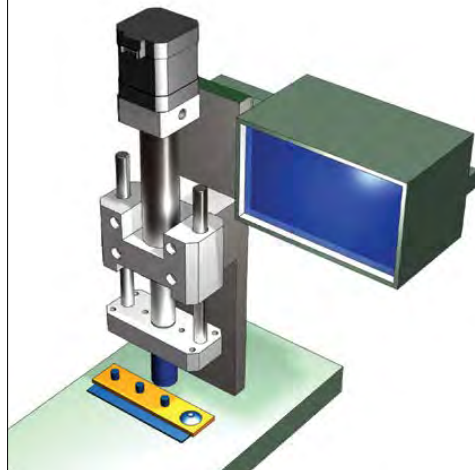

## CONTENTS

What is the ERD . . . . .ERD\_2

Rod-Style Actuators . . .ERD\_2

Applications . . . . .ERD\_3

FEATURES

ERD . . . . .ERD\_4

ERD SS2 . . . . .ERD\_6

SPECIFICATIONS

ERD . . . . .ERD\_8

PERFORMANCE

ERD . . . . .ERD\_10

GD2 . . . . .ERD\_18

DIMENSIONS

ERD-10, 15, 20

**Actuator** . . . . .ERD\_20

**Options:** IP67, FFG . .ERD\_21

FM2, . . . . .ERD\_23

TRR, PCD . . . . .ERD\_24

SS2 . . . . .ERD\_25

GD2 . . . . .ERD\_26

ERD-22, 25, 30

**Actuator** . . . . .ERD\_27

**Options:** FFG . . . . .ERD\_27

FM2, TRR, HYG1 . . . .ERD\_28

Alternative Motors . . .ERD\_29

SWITCHES . . . . .ERD\_30

Appl. Data Worksheet ERD\_32

Selection Guidelines . .ERD\_33

Service Parts . . . . .ERD\_34

Ordering . . . . .ERD\_35

## Other Applications:

- Aligning
- Animation
- Assembly
- Automatic tool changers
- Automotive
- Converting
- Conveyors
- Diverting
- Fillers
- Formers
- Gating
- Heat staking
- Laser positioning
- Material handling systems
- Medical equipment
- Motion simulators
- Open / close doors
- Packaging equipment
- Parts clamping
- Patient lifts
- Pick & place
- Plate positioning change
- Press fit
- Product changeover
- Product test simulations
- Robot manipulator arms
- Sonic welding
- Sorting
- Table positioning
- Tension control
- Test stands
- Volumetric pumps
- Web guidance
- Wire winding

# ERD – ELECTRIC ROD-STYLE ACTUATOR

**ENDURANCE TECHNOLOGY**<sup>SM</sup>

*Endurance Technology features are designed for maximum durability to provide extended service life.*

The ERD is an economical rod-style electric actuator designed as an alternative to pneumatic cylinders and an option for automating manual processes. The ERD is compatible with many NEMA & metric mount stepper and servo motors to create a flexible, powerful electric actuator solution. Built-to-order in stroke lengths up to 1.219 m (48").

## MULTIPLE SCREW TECHNOLOGIES

### YOU CAN CHOOSE:

- Solid nuts of bronze (15, 20 sizes) Or engineered resins (10, 15 sizes) offer quiet performance at the lowest cost
- Ball screws (10, 15, 20, 22, 25, 30 sizes) offer efficiency at a cost effective price; low-backlash available
- Roller screws provide the highest thrust and life ratings available (22, 25, 30 sizes only)



## OVERSIZED MAIN BEARING

- Oversized for long life
- Accommodates high thrust load

## PATENTED

## THREADED NOSE MOUNT WITH JAM NUT

- Metric threads
- Convenient mounting for many applications (10, 15, 20 sizes)



## THREADED ROD END

- Compatible with many commercially available metric rod end accessories
- Standard metric threads
- 10, 15, 20 male threads; 22, 25, 30 female threads

## INTERNAL MAGNET

- This standard feature accommodates reed and solid state switches anywhere on the main tube

## 300 SERIES STAINLESS-STEEL MAIN TUBE

- 300 Series stainless-steel main tube provides high rigidity and corrosion resistance

## NOSE BEARING

- Engineered resins for smooth operation
- Provides critical support of thrust rod

## STAINLESS-STEEL THRUST TUBE

- 300 series stainless-steel thrust tube provides high rigidity and corrosion resistance



## MOTOR ORIENTATION & MOTOR CHOICES

### **LM1** – INLINE

- Inline option directly couples the driving shaft and is typically a one-piece housing construction for optimum alignment and support of the motor

### **RP** – REVERSE PARALLEL

- Reverse-parallel option minimizes the overall length and offers a belt reduction drive with a 1:1 or 2:1 ratio.



**NEMA OR  
YOUR MOTOR  
HERE**

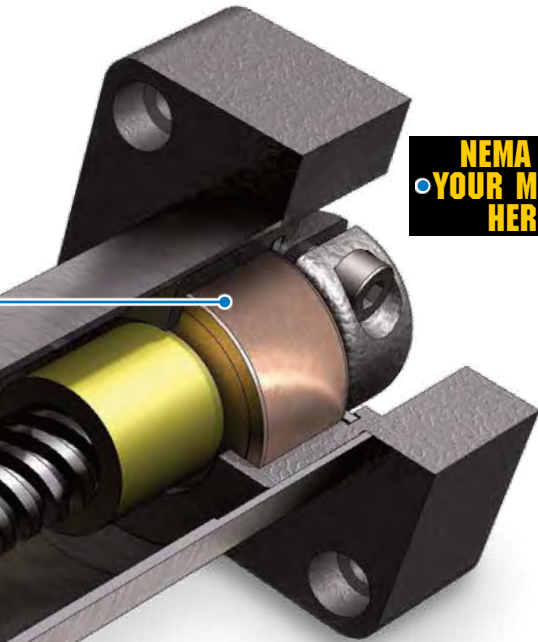

### **GUIDE (GD2 OPTION)**

- Load guidance, tooling plate and anti-rotate
- Made of aluminum (10, 15, 20 sizes)



### **INTEGRAL GUIDE RODS AND BEARINGS**

- Stainless-steel guide rods provide high rigidity and low deflection
- Four composite bearings support the load for smooth consistent motion

## OPTIONS



### **TRR** – TRUNNION MOUNT

For applications that require pivoting, 300 series stainless steel construction. Available on all sizes



### **PCD** – REAR CLEVIS MOUNT

For applications that require rear pivot, (Available for 15, 20, 22, 25, 30 sizes with **RP** mounting only)



### **FM2** – FOOT MOUNT\*

For applications that require bottom mounting, 300 series stainless steel construction. Available on all sizes



### **FFG** – FRONT FLANGE MOUNT\*

For front mounting applications, 300 series stainless steel construction. Available on all sizes



### **SWITCHES\***

Choose from: Reed, Solid State PNP or NPN, all available in normally open. Available on all sizes

### **ARI** – INTERNAL ANTI-ROTATE

When anti-rotation is required. For 15, 20, 22, 25, 30 sizes.

### **IP67 & IP69K** RATINGS

[static rating] An IP67 upgrade (Viton seals) for protection against water and dust ingress IP69K (Polyurathane seals) also protects from high pressure wash-down (see page ERD\_34 for ordering details)

### **SS1** – STAINLESS STEEL

Same ERD actuator made of all 300 series stainless steel for corrosion resistance. For 10, 15, 20, 22, 25, 30 sizes.

### **SS2** – STAINLESS STEEL

SS1 option plus IP67 or IP69K and protective motor enclosure (see page ERD\_6) Available on 10, 15, 20 sizes

### **GD2** – GUIDE

For applications that require anti-rotation, or guidance and load bearing. Made of lightweight aluminum Available on 10, 15, 20 sizes

\*NOTE: Foot Mount, Front Flange Mount and Switches are shipped together with the actuator but are not installed by Tolomatic.

# SS2 OPTION – ERD10, 15 & 20

## ALL 300 SERIES STAINLESS STEEL, IP69K, MOTOR PROTECTION

### ENDURANCE TECHNOLOGY<sup>SM</sup>

Endurance Technology features are designed for maximum durability to provide extended service life.

The all 300 series stainless-steel ERD for 10, 15 & 20 sizes incorporates hygienic design principles and includes a protective enclosure for Tolomatic stepper/servo motors. (10 size: stepper motor only)  
The SS2 has an IP69K rating (static). The SS2 is built-to-order in stroke lengths up to 0.6 m (24").

#### FLEXIBLE CONNECTION

- Choice of cord grips (PVDF) or industry standard conduit threads



SS23  
1 or 2 cord grips determined if encoder is selected



SS21  
NPT 1/2" conduit thread  
&  
SS22  
M20x1.5 conduit thread

#### SMOOTH EXTERIOR

- This primary design decision eases cleanup and helps to prevent bacterial growth

#### IP69K RATED

- To withstand high-pressure wash-down
- Clean-in-place compatible

#### MOTOR PROTECTION

- Motor enclosure made of stainless steel designed to protect motor with IP69K rating (static)

**Tolomatic**... MAXIMUM DURABILITY  
EXCELLENCE IN MOTION



# ERD22, 25 & ERD30 STANDARD

## ALL 300 SERIES STAINLESS STEEL, IP69K

The all 300 series stainless-steel ERD incorporates hygienic design principles and has an IP69K rating (static). Available in 22, 25 & 30 sizes, the ERD is built-to-order in stroke lengths up to 1.219 m (48") with force up to 35 kN (7,868 lbf).

**NOTE: ERD22, ERD25, ERD30 are replaced by the improved design of the RSH22, RSH25, RSH30**

- **HYGI** Option: USDA approved hygienic design [NSF/ANIS3-A 14159-1-2010] (see #2190-4003 for usage details)

### BREATHER / PURGE PORT

- Helps prevent contaminants from entering into actuator

### WELDED SEAMS

- Leaving no gaps which eases cleanup and helps to prevent bacterial growth

### USDA SCRAPER

- Available with USDA certified option **HYGI**

### ALL 300 SERIES STAINLESS STEEL CONSTRUCTION

- 300 series stainless steel for corrosion resistance
- Simplifies and lowers cost of machine design by eliminating the need for protective guards around standard actuators

### DURABLE SEALS

- Polyurethane for IP69K ingress protection and resistance to caustic wash-down

### STAINLESS STEEL FASTENERS

- Standard metric threads
- Hex fasteners for sturdy construction without potential particle collection areas

### GREASE PORT

- Screw re-lubrication system provides extended screw life
- Convenient lubrication without disassembly

### THREADED ROD END

- Compatible with many commercially available metric rod end accessories
- Standard metric threads
- 10, 15, 20 male threads; 22, 25, 30 female threads

# ERD – Electric Rod-Style Actuator

sizeit.tolomatic.com for fast, accurate actuator selection



SIZE: ALL

## SPECIFICATIONS

### SPECIFICATIONS (US conventional measurement)

ERD SIZE	MAXIMUM STROKE*	SCREW CODE	LEAD	LEAD ACCURACY	BACKLASH	MAXIMUM THRUST	DYNAMIC LOAD RATING	INERTIA			WEIGHT					WEIGHT (GD2 adder)		
								LMI	RP	Per Inch	LMI (AL)	LMI (SS)	RP (AL)	RP (SS)	(SS2 adder)	Per Inch	Base	Per Inch
in	in/rev	in/ft	in	lbf	lbf	lb-in <sup>2</sup>	lb-in <sup>2</sup>	lb-in <sup>2</sup>	lb	lb	lb	lb	lb	lb	lb	lb		
10	10	SN01	1.000	0.007	0.007	40	NA	0.0022	-	0.0006	0.411	-	-	-	2.280	0.069	1.028	0.061
		SN02	0.500	0.007	0.007	40	NA	0.0022	-	0.0006	0.411	-	-	-	2.280	0.069	1.028	0.061
		SN05	0.200	0.007	0.007	40	NA	0.0022	-	0.0006	0.411	-	-	-	2.280	0.069	1.028	0.061
		BNM05	0.197	0.004	0.005	100	240	0.0040	-	0.0014	0.607	-	-	-	2.280	0.087	1.028	0.061
15	24	SN01	1.000	0.006	0.007	75	NA	0.0104	0.2101	0.0017	1.079	-	4.230	7.761	5.771	0.126	2.297	0.095
		SN02	0.500	0.005	0.007	75	NA	0.0104	0.2101	0.0017	1.079	-	4.230	7.761	5.771	0.126	2.297	0.095
		SN05	0.200	0.006	0.007	75	NA	0.0104	0.2101	0.0017	1.079	-	4.230	7.761	5.771	0.126	2.297	0.095
		BNM05	0.197	0.004	0.005	200	450	0.0178	0.2208	0.0044	1.170	-	4.230	7.761	5.771	0.159	2.297	0.095
		BNM10	0.394	0.004	0.005	200	400	0.0178	0.2208	0.0044	1.170	-	4.230	7.761	5.771	0.159	2.297	0.095
		BZ10	0.100	0.006	0.008	200	NA	0.0178	0.2208	0.0044	1.170	-	4.230	7.761	5.771	0.159	2.297	0.095
20	24	BNM05	0.197	0.004	0.005	500	900	0.0628	0.4102	0.0263	7.575	-	23 FRM	23 FRM	7.552	0.325	6.455	0.256
		BNM10	0.394	0.004	0.005	500	900	0.0628	0.4102	0.0263	7.575	-	5.610	9.030	7.552	0.325	6.455	0.256
		BNM20	0.788	0.004	0.004	500	2560	0.0628	0.4102	0.0105	7.575	-	34 FRM	34 FRM	7.552	0.325	6.455	0.256
		BZ10	0.100	0.006	0.008	500	NA	0.0628	0.4102	0.0105	7.575	-	6.050	9.448	7.552	0.325	6.455	0.256
22	39.4	BN02	0.500	0.004	0.015	1600	2836	0.4449	0.5489	0.0086	-	11.05	-	20.18	-	0.43	-	0.43
		BN05	0.200	0.003	0.015	950	1624	0.4449	0.5489	0.0086	-	11.05	-	20.18	-	0.43	-	0.43
		BNM05	0.197	0.002	0.004	1000	1958	0.4267	0.5307	0.0044	-	10.81	-	19.94	-	0.40	-	0.40
		BNM10	0.394	0.002	0.004	900	1214	0.4267	0.5307	0.0044	-	10.81	-	19.94	-	0.40	-	0.40
	24	BNM20	0.787	0.004	0.004	1000	2560	0.4527	0.5567	0.0105	-	11.12	-	20.25	-	0.45	-	0.45
		RNM04	0.157	0.0004	0.0012	1700	5577	0.4226	0.5266	0.0033	-	10.79	-	19.92	-	0.39	-	0.39
		RNM05	0.197	0.0004	0.0012	1700	5577	0.4226	0.5266	0.0033	-	10.79	-	19.92	-	0.39	-	0.39
		RNM10	0.394	0.0004	0.0012	1556	5577	0.4226	0.5266	0.0033	-	10.79	-	19.92	-	0.39	-	0.39
25	39.4	BN01	1.000	0.004	0.002	711	2500	0.8634	0.7749	0.0277	-	31.77	-	53.85	-	0.87	-	0.87
		BN02	0.500	0.004	0.015	1423	5418	0.8634	0.7749	0.0277	-	31.73	-	53.81	-	0.87	-	0.87
		BN04	0.250	0.004	0.015	2846	5238	0.8634	0.7749	0.0277	-	31.73	-	53.81	-	0.87	-	0.87
		BNM05	0.197	0.002	0.004	2000	3395	0.8550	0.7740	0.0260	-	31.34	-	53.42	-	0.86	-	0.86
	36	BNM10	0.394	0.002	0.004	1750	3372	0.8550	0.7740	0.0260	-	31.75	-	53.83	-	0.86	-	0.86
		BNM25	0.984	0.004	0.005	700	2537	0.8550	0.7740	0.0260	-	31.50	-	53.58	-	0.86	-	0.86
		RNM04	0.157	0.0004	0.0012	4159	12762	0.7734	0.7659	0.0106	-	31.29	-	53.37	-	0.78	-	0.78
		RNM05	0.197	0.0004	0.0012	3878	12762	0.7734	0.7659	0.0106	-	31.29	-	53.37	-	0.78	-	0.78
30	48	BN04	0.250	0.004	0.015	4500	7143	1.0872	2.1018	0.1401	-	32.66	-	54.73	-	1.39	-	1.39
		BNM05	0.197	0.002	0.004	3000	6714	1.1232	2.1378	0.1702	-	34.07	-	56.14	-	1.44	-	1.44
		BNM10	0.394	0.002	0.004	2950	7476	1.1233	2.1378	0.1702	-	35.48	-	57.55	-	1.44	-	1.44
		BNM20	0.787	0.002	0.005	1845	9622	1.1232	2.1378	0.1702	-	33.58	-	55.65	-	1.44	-	1.44
	36	RNM05	0.197	0.0004	0.0012	7868	12762	0.632	1.201	0.0531	-	31.45	-	53.52	-	1.20	-	1.20
		RNM10	0.394	0.0004	0.0012	7943	12762	0.632	1.201	0.0531	-	31.45	-	53.52	-	1.20	-	1.20

**NOTE:**  
ERD22,  
ERD25,  
ERD30 are  
replaced by  
the improved  
design of the  
RSH22,  
RSH25,  
RSH30

\*Longer stroke length modification available upon request.

**Standard Temperature range	40° to 130° F (4.4° to 54.4° C)
IP rating	<b>40</b> (static) standard for 10, 15, 20 sizes <b>69k</b> (static) standard for 22, 25, 30 sizes

\*\*Contact Tolomatic to review application for operations outside the standard temperature range.

### SIDE LOAD CONSIDERATIONS

The standard ERD rod-style actuator is not meant to be used in applications where side loading occurs. If side loading exists in the application consider the GD2 guided option.

Loads must be guided and supported. Loads should be aligned with the line of motion of the thrust rod.

Side loading will affect the life of the actuator.

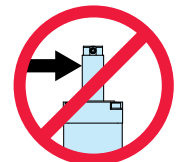

SCREW CODE	DESCRIPTION
BN	Ball Nut
BNH	Ball Nut H-series
BNL	Low-Backlash Ball Nut
BNM	Ball Nut Metric
BZ	Bronze Nut
RNM	Roller Nut
SN	Solid Nut



# ERD – Electric Rod-Style Actuator

sizeit.tolomatic.com for fast, accurate actuator selection



SIZE: ALL

## SPECIFICATIONS

### SPECIFICATIONS (metric measurement)

ERD SIZE	MAXIMUM STROKE*	SCREW CODE	LEAD	LEAD ACCURACY	BACKLASH	MAXIMUM THRUST	DYNAMIC LOAD RATING	INERTIA			WEIGHT					WEIGHT (GD2 adder)		
								LMI	RP	Per 25mm	LMI (AL)	LMI (SS)	RP (AL)	RP (SS)	(SS2 adder)	Per 25mm	Base	Per Inch
								Base	Base		kg	kg	kg	kg	kg			
10	254.0	SN01	25.4	0.18	0.18	188	NA	0.64	-	0.18	0.186	-	-	-	1.034	0.031	0.466	0.028
		SN02	12.7	0.18	0.18	188	NA	0.64	-	0.18	0.186	-	-	-	1.034	0.031	0.466	0.028
		SN05	5.08	0.18	0.18	188	NA	0.64	-	0.18	0.186	-	-	-	1.034	0.031	0.466	0.028
		BNM05	5.00	0.10	0.13	445	1068	1.16	-	0.41	0.275	-	-	-	1.034	0.039	0.466	0.028
15	609.6	SN01	25.4	0.15	0.18	334	NA	3.04	61.48	0.50	0.489	-	1.919	3.520	2.618	0.057	1.042	0.043
		SN02	12.7	0.13	0.18	334	NA	3.04	61.48	0.50	0.489	-	1.919	3.520	2.618	0.057	1.042	0.043
		SN05	5.08	0.15	0.18	334	NA	3.04	61.48	0.50	0.489	-	1.919	3.520	2.618	0.057	1.042	0.043
		BNM05	5.00	0.10	0.13	890	2002	5.21	64.61	1.28	0.531	-	1.919	3.520	2.618	0.072	1.042	0.043
		BNM10	10.00	0.10	0.13	890	1779	5.21	64.61	1.28	0.531	-	1.919	3.520	2.618	0.072	1.042	0.043
		BZ10	2.54	0.15	0.20	890	NA	5.21	64.61	1.28	0.531	-	1.919	3.520	2.618	0.072	1.042	0.043
20	609.6	BNM05	5.00	0.10	0.13	2224	4003	18.38	120.04	7.70	3.436	-	23 FRM	23 FRM	3.426	0.147	2.928	0.116
		BNM10	10.00	0.10	0.13	2224	4003	18.38	120.04	7.70	3.436	-	2.545	4.096	3.426	0.147	2.928	0.116
		BNM20	20.00	0.10	0.10	2224	11387	18.38	120.04	3.07	3.436	-	34 FRM	34 FRM	3.426	0.147	2.928	0.116
		BZ10	2.54	0.15	0.20	2224	NA	18.38	120.04	3.07	3.436	-	2.744	4.286	3.426	0.147	2.928	0.116
22	1000	BN02	12.70	0.10	0.38	7117	12615	130.36	160.83	2.52	-	5.01	-	9.15	-	0.20	-	-
		BN05	5.08	0.08	0.38	4226	7224	130.36	160.83	2.52	-	5.01	-	9.15	-	0.20	-	-
		BNM05	5.00	0.05	0.10	4448	8710	125.03	155.50	1.29	-	4.90	-	9.04	-	0.18	-	-
		BNM10	10.00	0.05	0.10	4003	5400	125.03	155.50	1.29	-	4.90	-	9.04	-	0.18	-	-
	BNM20	20.00	0.10	0.10	4448	11387	132.65	163.12	3.08	-	5.04	-	9.19	-	0.20	-	-	
	609.6	RNM04	4.00	0.01	0.03	7562	24808	123.83	154.30	0.97	-	4.89	-	9.04	-	0.18	-	-
		RNM05	5.00	0.01	0.03	7562	24808	123.83	154.30	0.97	-	4.89	-	9.04	-	0.18	-	-
		RNM10	10.00	0.01	0.03	3781	24808	123.83	154.30	0.97	-	4.89	-	9.04	-	0.18	-	-
25	1000	BN01	25.40	0.102	0.05	3163	11120	252.98	227.03	8.12	-	14.41	-	24.42	-	0.39	-	-
		BN02	12.70	0.102	0.05	6330	29100	252.98	227.03	8.12	-	14.39	-	24.41	-	0.39	-	-
		BN04	6.35	0.102	0.05	12660	23300	252.98	227.03	8.12	-	14.39	-	24.41	-	0.39	-	-
		BNM05	5.00	0.051	0.10	8896	15101	250.52	226.79	7.62	-	14.22	-	24.23	-	0.39	-	-
	BNM10	10.00	0.051	0.10	7784	15000	250.52	226.79	7.62	-	14.40	-	24.42	-	0.39	-	-	
	BNM25	25.00	0.102	0.13	3114	11285	250.52	226.79	7.62	-	14.29	-	24.30	-	0.39	-	-	
	914.4	RNM04	4.00	0.0102	0.03	18500	56768	226.61	224.40	3.11	-	14.19	-	24.21	-	0.35	-	-
		RNM05	5.00	0.0102	0.03	17250	56768	226.61	224.40	3.11	-	14.19	-	24.21	-	0.35	-	-
RNM10		10.00	0.0102	0.03	18500	56768	226.61	224.40	3.11	-	14.19	-	24.21	-	0.35	-	-	
30	1219.2	BN04	6.35	0.102	0.38	20017	31774	318.56	615.84	41.05	-	14.81	-	24.83	-	0.63	-	-
		BNM05	5.00	0.051	0.10	13345	29865	329.11	626.38	49.87	-	15.45	-	25.47	-	0.65	-	-
		BNM10	10.00	0.051	0.10	13122	33255	329.11	626.38	49.87	-	16.09	-	26.11	-	0.65	-	-
		BNM20	20.00	0.051	0.13	8207	42800	329.11	626.38	49.87	-	15.23	-	25.24	-	0.65	-	-
	914.4	RNM05	5.00	0.010	0.03	34999	56768	184.94	351.46	1.55	-	14.27	-	24.28	-	0.54	-	-
	RNM10	10.00	0.010	0.03	35332	56768	184.94	351.46	1.55	-	14.27	-	24.28	-	0.54	-	-	

**NOTE:**  
ERD22,  
ERD25,  
ERD30 are  
replaced by  
the improved  
design of the  
RSH22,  
RSH25,  
RSH30

#### What is an IP Rating?

The IP Code (or Ingress Protection Rating) consists of the letters IP followed by two digits and an optional letter. As defined in international standard IEC 60529, it classifies the degrees of protection provided against the intrusion of solid objects (including body parts like hands and fingers), dust, accidental contact, and water in electrical enclosures.

The IP69K test specifies a spray nozzle that is fed with 80°C water at 8–10MPa (80–100bar) and a flow rate of 14–16L/min. The nozzle is held 10–5 cm from the tested device at angles of 0°, 30°, 60° and 90° for 30s each. The test device sits on a turntable that rotates once every 12s (5rpm).

#### SOLIDS, FIRST DIGIT:

4	>1 mm	Most wires, screws, etc.
6	Dust tight	No ingress of dust; complete protection against solid object intrusion

#### LIQUIDS, SECOND DIGIT (static rating)

0	Not protected	
7	Immersion up to 1 m	Ingress of water in harmful quantity shall not be possible when the enclosure is immersed in water under defined conditions of pressure and time (up to 1 m of submersion).
9K	High pressure, high temp. wash-down	As above, plus ingress of water in harmful quantity shall not be possible when the enclosure is subject to high pressure, high temperature wash-down.

#### What Does IP69K mean?

German standard DIN 40050-9 extends the IEC 60529 rating system described above with an IP69K rating for high-pressure, high-temperature wash-down applications.[4] Such enclosures must not only be dust tight (IP6X), but also able to withstand high-pressure and steam cleaning.

The first digit indicates the level of protection that the enclosure provides against access to hazardous parts (e.g., electrical conductors, moving parts) and the ingress of solid foreign objects.

The second digit indicates the level of protection that the enclosure provides against harmful ingress of water.

# ERD – Electric Rod-Style Actuator

sizeit.tolomatic.com for fast, accurate actuator selection



ACTUATOR SIZING

SIZE: ERD10

PERFORMANCE

## CRITICAL SPEED CAPACITY

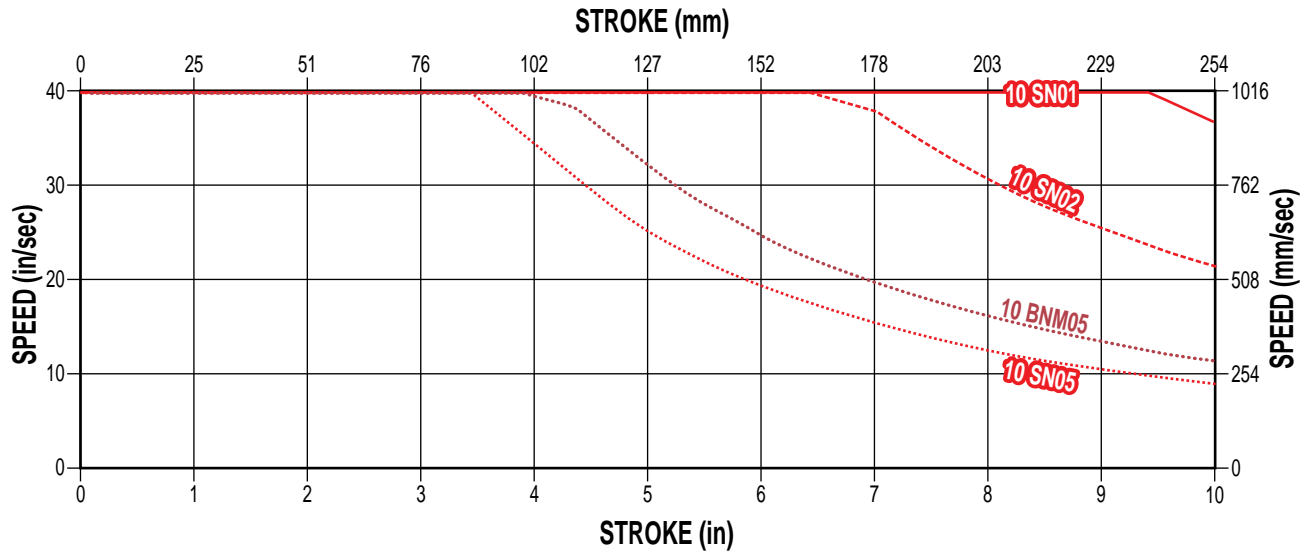

## PV LIMITS (ACME NUTS)

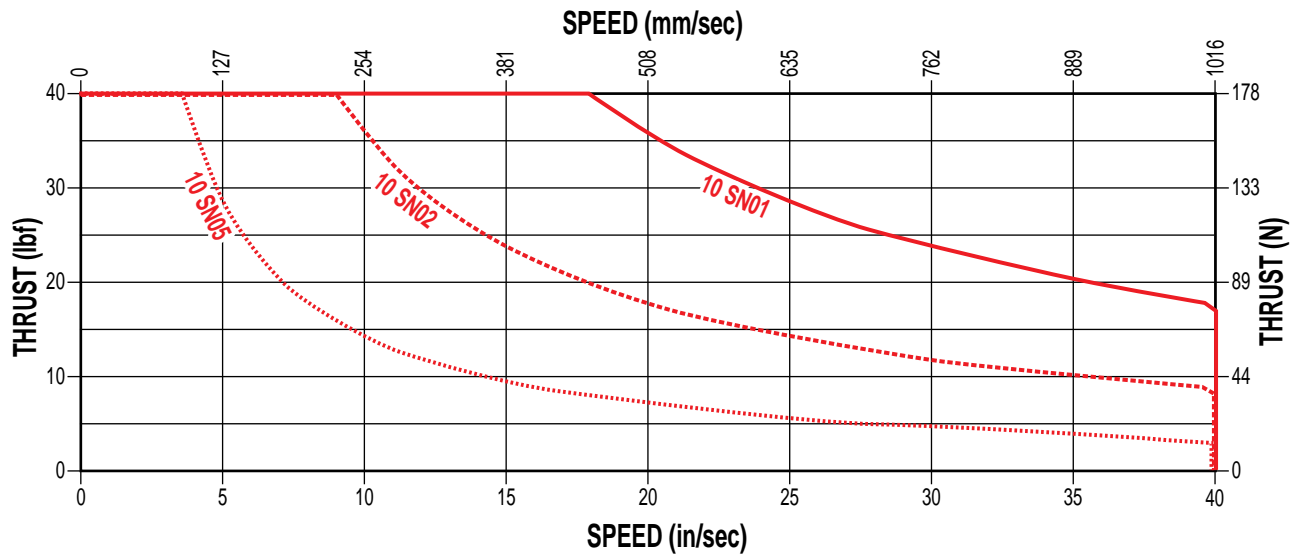

(Pressure Velocity of Acme Nut)

**PV LIMITS:** Any material which carries a sliding load is limited by heat buildup. The factors that affect heat generation rate in an application are the pressure on the nut in pounds per square inch and the surface velocity in feet per minute. The product of these factors provides a measure of the severity of an application.

$$P \times V \leq 0.1$$

$$\left( \frac{\text{Thrust}}{\text{Max. Thrust Rating}} \right) \times \left( \frac{\text{Speed}}{\text{Max. Speed Rating}} \right) \leq 0.1$$



## MAXIMUM THRUST vs STROKE

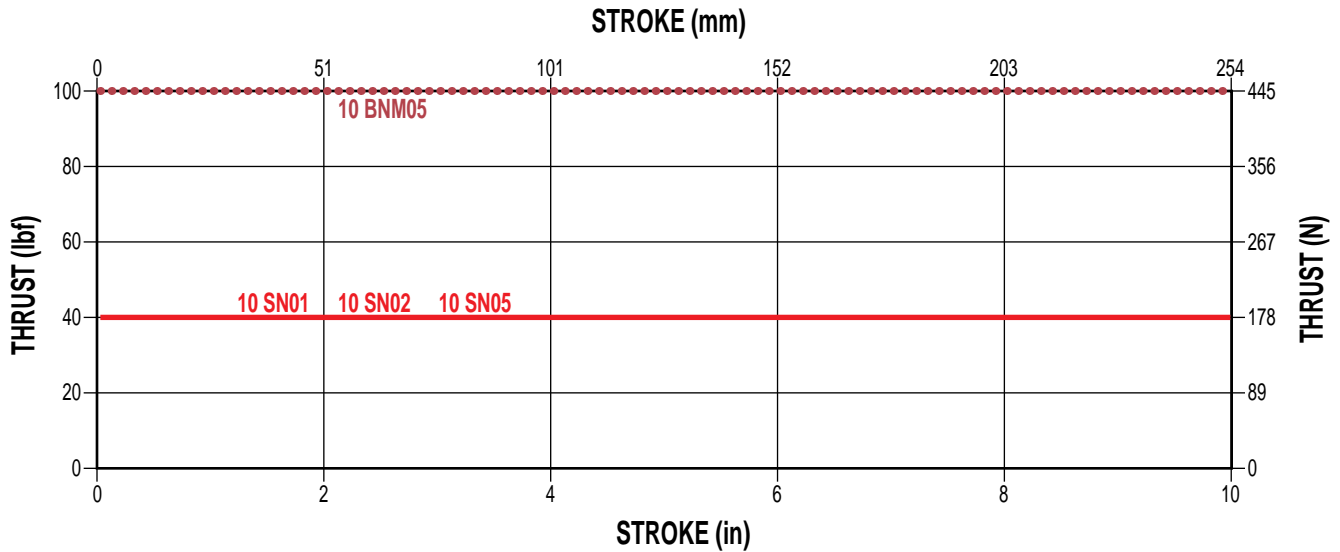

## SCREW LIFE (BALL NUTS)

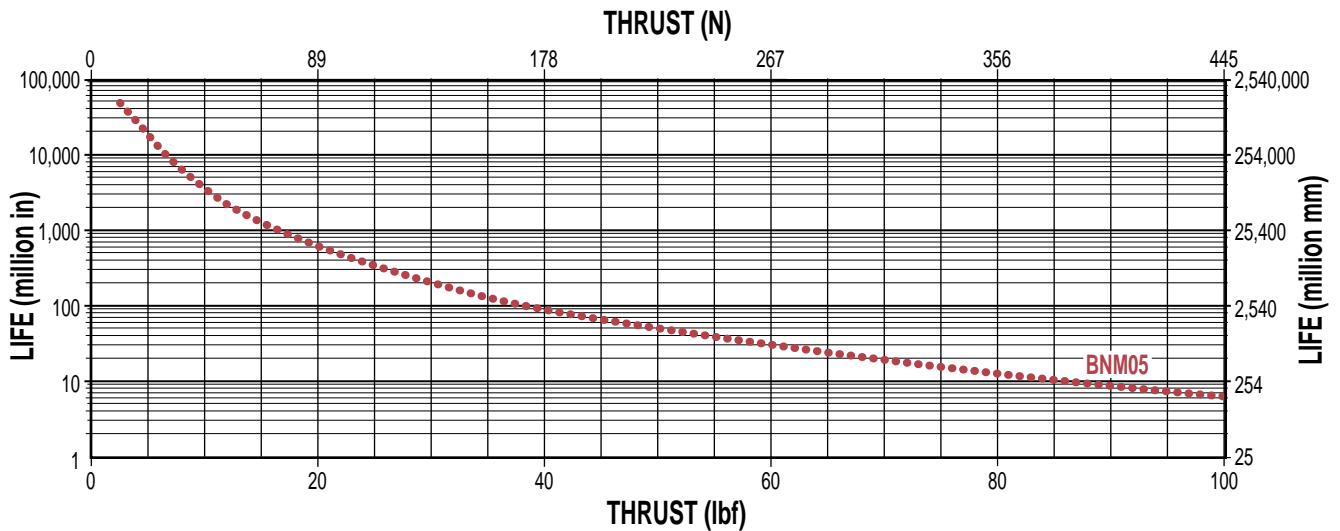

*NOTE: The L<sub>10</sub> expected life of a ball screw linear actuator is expressed as the linear travel distance that 90% of properly maintained ball screw manufactured are expected to meet or exceed. This is not a guarantee and this graph should be used for estimation purposes only.*

The underlying formula that defines this value is:

$$L_{10} = \left( \frac{C}{P_e} \right)^3 \cdot \ell =$$

L<sub>10</sub> Travel life in millions of units (in or mm), where:

C = Dynamic load rating (lbf) or (N)

P<sub>e</sub> = Equivalent load (lbf) or (N)

If load is constant across all movements then:

ℓ actual load = equivalent load  
ℓ = Screw lead (in/rev) (mm/rev)

Use the "Equivalent Load" calculation below, when the load is not constant throughout the entire stroke. In cases where there is only minor variation in loading, use greatest load for life calculations.

Where: 
$$P_e = \sqrt[3]{\frac{L_1(P_1)^3 + L_2(P_2)^3 + L_3(P_3)^3 + L_n(P_n)^3}{L}}$$

P<sub>e</sub> = Equivalent load (lbf) or (N)

P<sub>n</sub> = Each increment at different load (lbf) or (N)

L = Total distanced traveled per cycle (extend + retract stroke)  
[L = L<sub>1</sub> + L<sub>2</sub> + L<sub>3</sub> + L<sub>n</sub>]

L<sub>n</sub> = Each increment of stroke at different load (in) or (mm)



# ERD – Electric Rod-Style Actuator

sizeit.tolomatic.com for fast, accurate actuator selection



ACTUATOR SIZING

SIZE: ERD15

PERFORMANCE

## CRITICAL SPEED CAPACITY

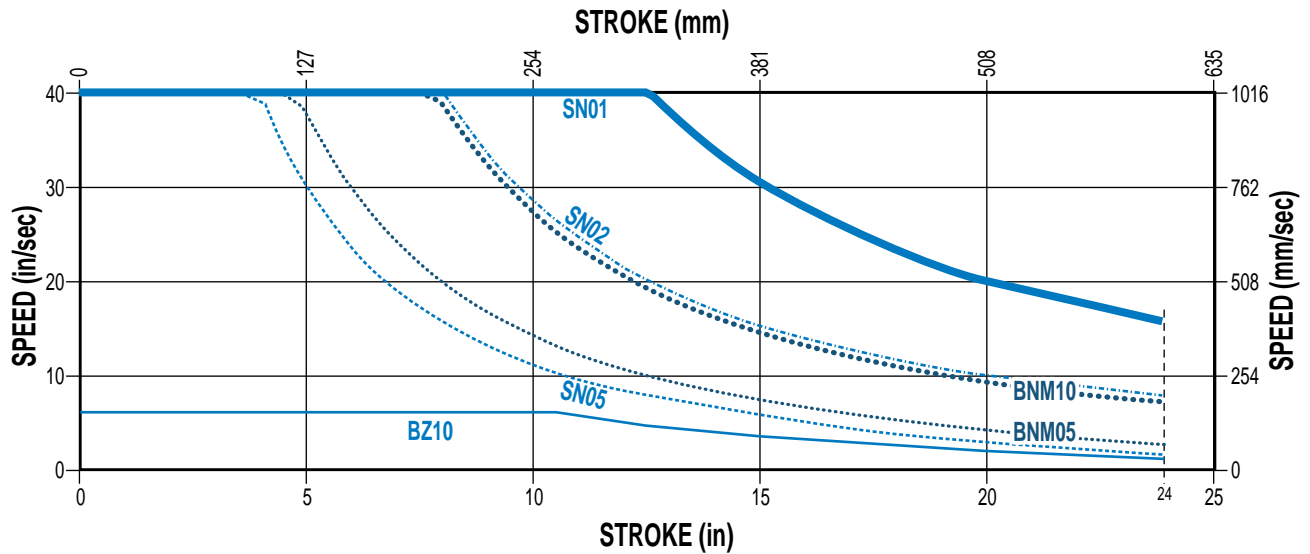

## PV LIMITS (ACME NUTS)

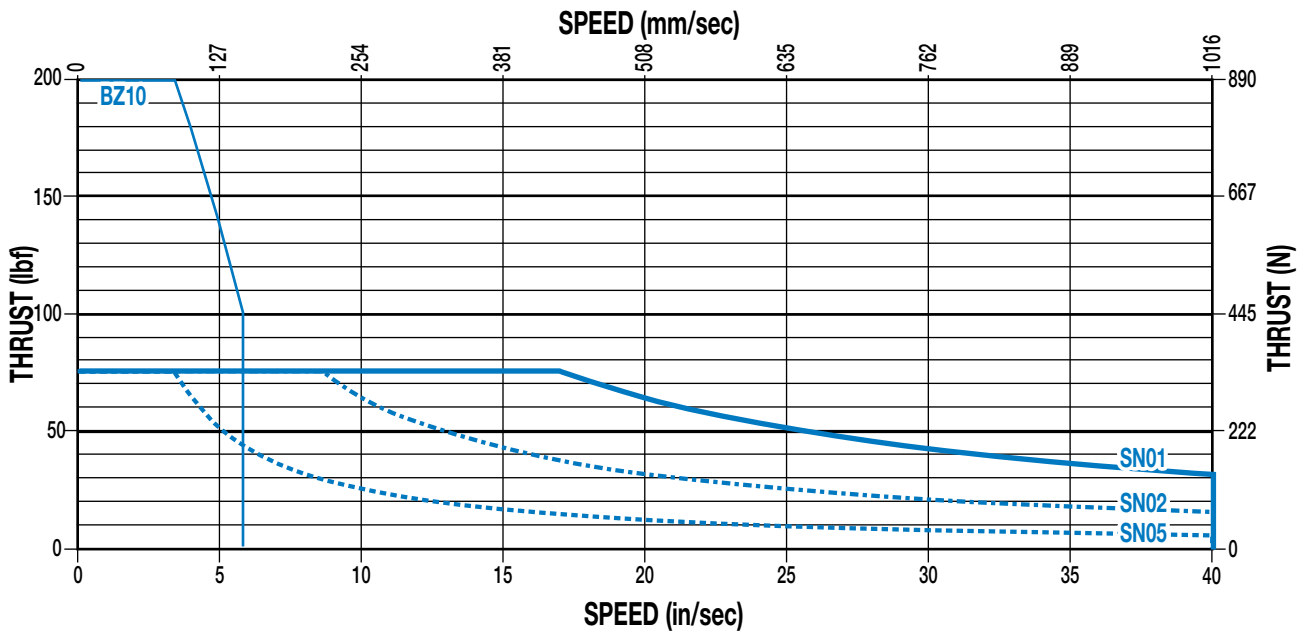

(Pressure Velocity of Acme Nut)

**PV LIMITS:** Any material which carries a sliding load is limited by heat buildup. The factors that affect heat generation rate in an application are the pressure on the nut in pounds per square inch and the surface velocity in feet per minute. The product of these factors provides a measure of the severity of an application.

$$P \times V \leq 0.1$$

$$\left( \frac{\text{Thrust}}{\text{(Max. Thrust Rating)}} \right) \times \left( \frac{\text{Speed}}{\text{(Max. Speed Rating)}} \right) \leq 0.1$$

# ERD – Electric Rod-Style Actuator

sizeit.tolomatic.com for fast, accurate actuator selection



SIZE: ERD15

PERFORMANCE

## MAXIMUM THRUST vs STROKE

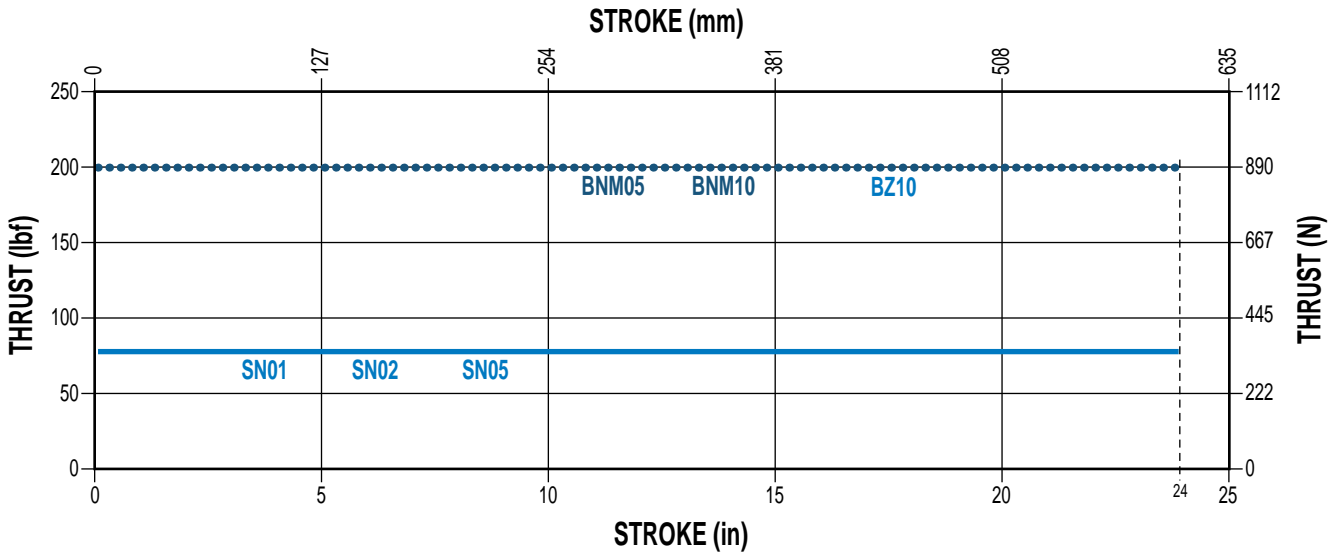

## SCREW LIFE (BALL NUTS)

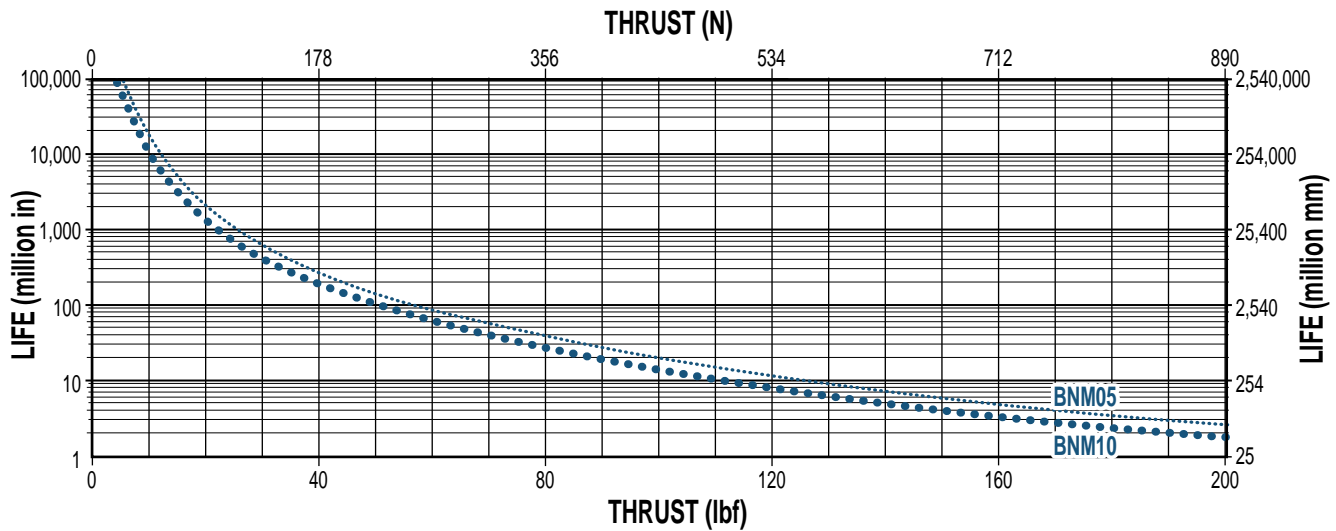

*NOTE: The  $L_{10}$  expected life of a ball screw linear actuator is expressed as the linear travel distance that 90% of properly maintained ball screw manufactured are expected to meet or exceed. This is not a guarantee and this graph should be used for estimation purposes only.*

The underlying formula that defines this value is:

$$L_{10} = \left( \frac{C}{P_e} \right)^3 \cdot \ell =$$

$L_{10}$  Travel life in millions of units (in or mm), where:

- $C$  = Dynamic load rating (lbf) or (N)
- $P_e$  = Equivalent load (lbf) or (N)
- If load is constant across all movements then:  
 $\ell$  actual load = equivalent load
- $\ell$  = Screw lead (in/rev) (mm/rev)

Use the "Equivalent Load" calculation below, when the load is not constant throughout the entire stroke. In cases where there is only minor variation in loading, use greatest load for life calculations.

$$\text{Where: } P_e = \sqrt[3]{\frac{L_1(P_1)^3 + L_2(P_2)^3 + L_3(P_3)^3 + L_n(P_n)^3}{L}}$$

- $P_e$  = Equivalent load (lbf) or (N)
- $P_n$  = Each increment at different load (lbf) or (N)
- $L$  = Total distanced traveled per cycle (extend + retract stroke)  
 $[L = L_1 + L_2 + L_3 + L_n]$
- $L_n$  = Each increment of stroke at different load (in) or (mm)

# ERD – Electric Rod-Style Actuator

sizeit.tolomatic.com for fast, accurate actuator selection



ACTUATOR SIZING

SIZE: ERD20

PERFORMANCE

## CRITICAL SPEED CAPACITY

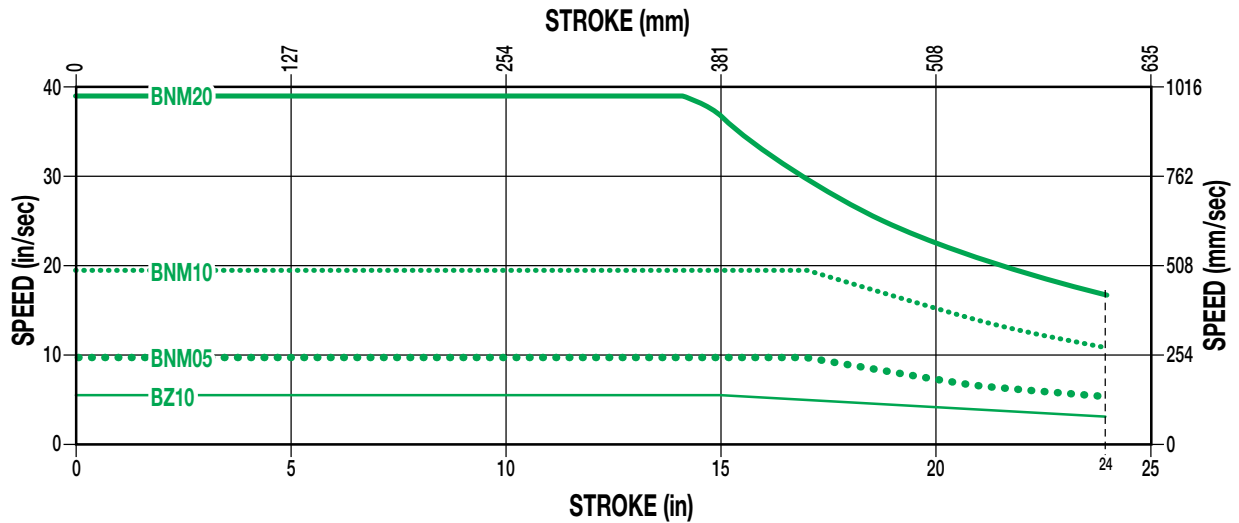

## MAXIMUM THRUST vs STROKE

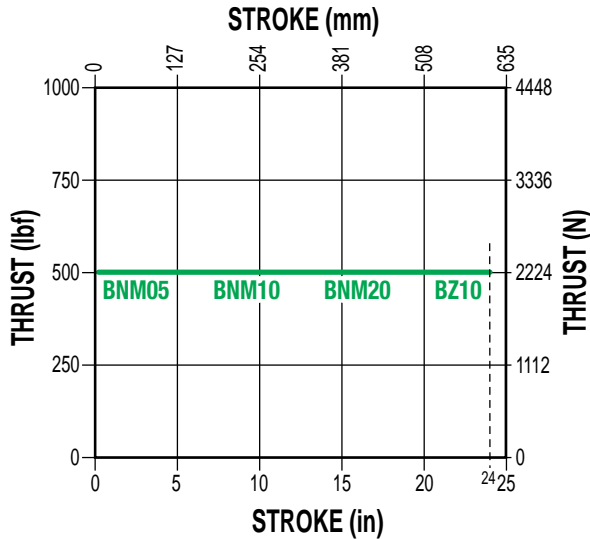

## PV LIMITS (BRONZE NUT)

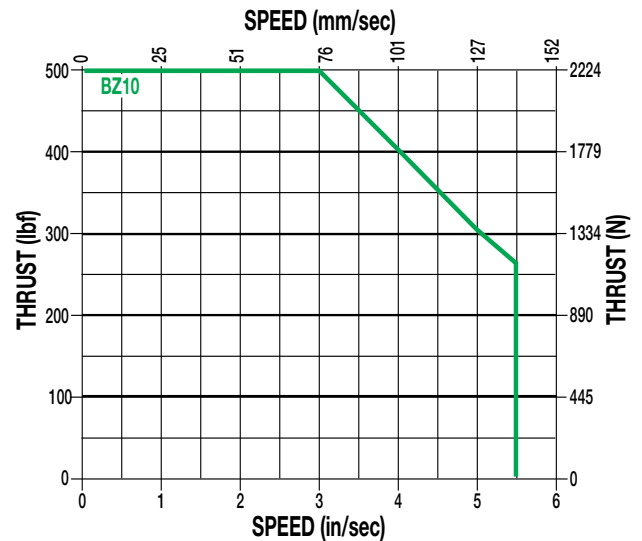

## SCREW LIFE

NOTE: See L<sub>10</sub> expected life calculation on page ERD\_13

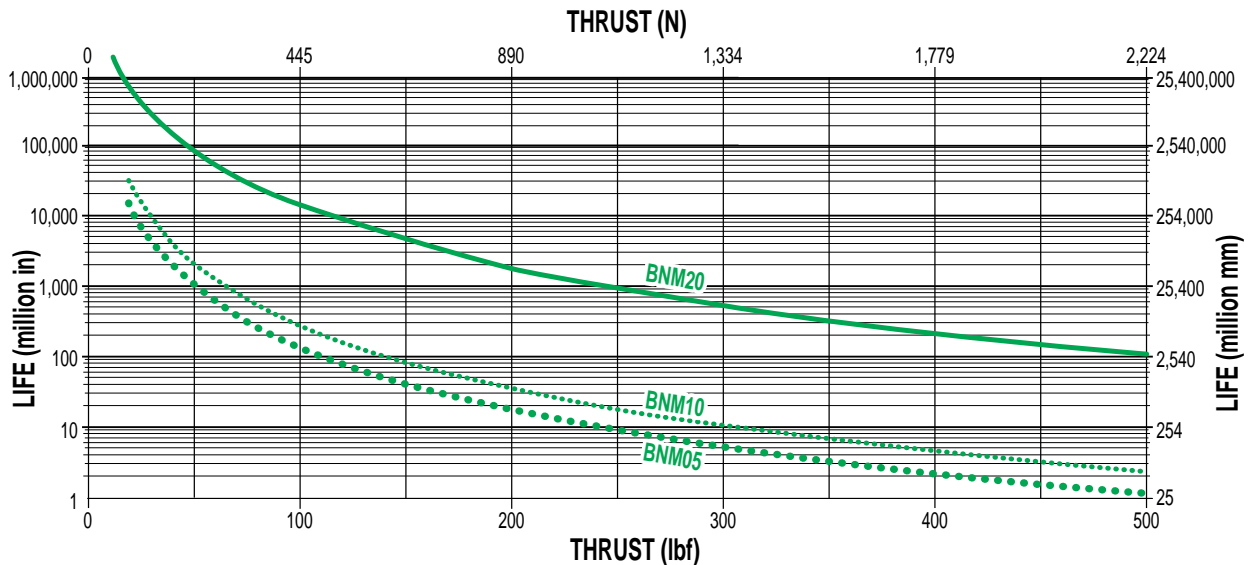



# ERD – Electric Rod-Style Actuator

sizeit.tolomatic.com for fast, accurate actuator selection



SIZE: ERD22

PERFORMANCE

## CRITICAL SPEED CAPACITY

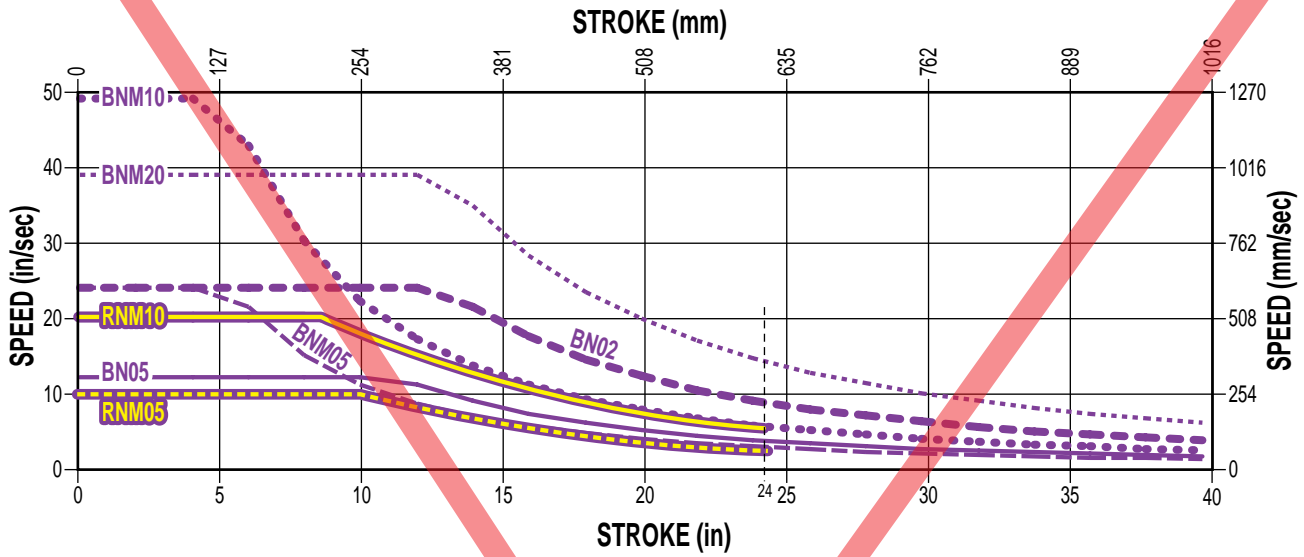

## MAXIMUM THRUST vs STROKE

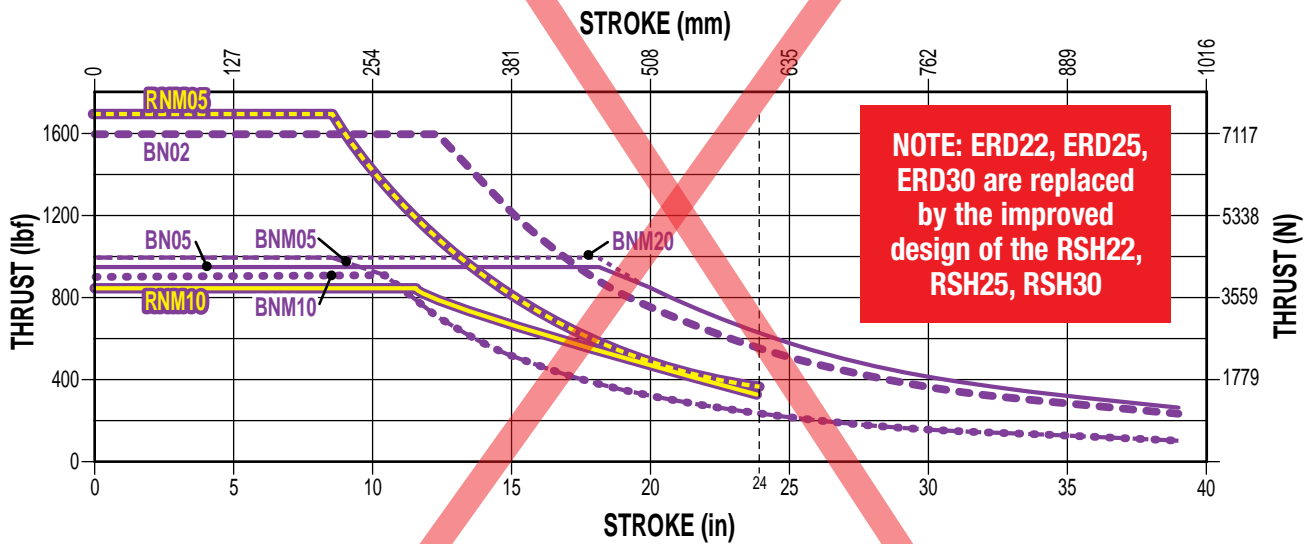

**NOTE: ERD22, ERD25, ERD30 are replaced by the improved design of the RSH22, RSH25, RSH30**

## SCREW LIFE

**NOTE: See L<sub>10</sub> expected life calculation on page ERD\_13**

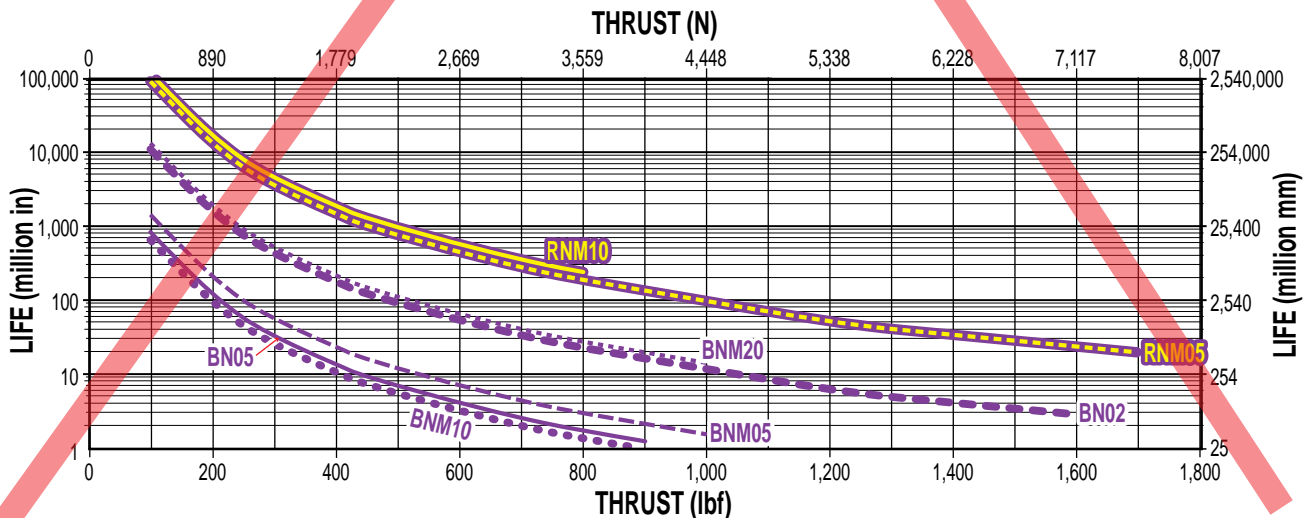

# ERD – Electric Rod-Style Actuator

sizeit.tolomatic.com for fast, accurate actuator selection



ACTUATOR SIZING

SIZE: **ERD25**

**PERFORMANCE**

## CRITICAL SPEED CAPACITY

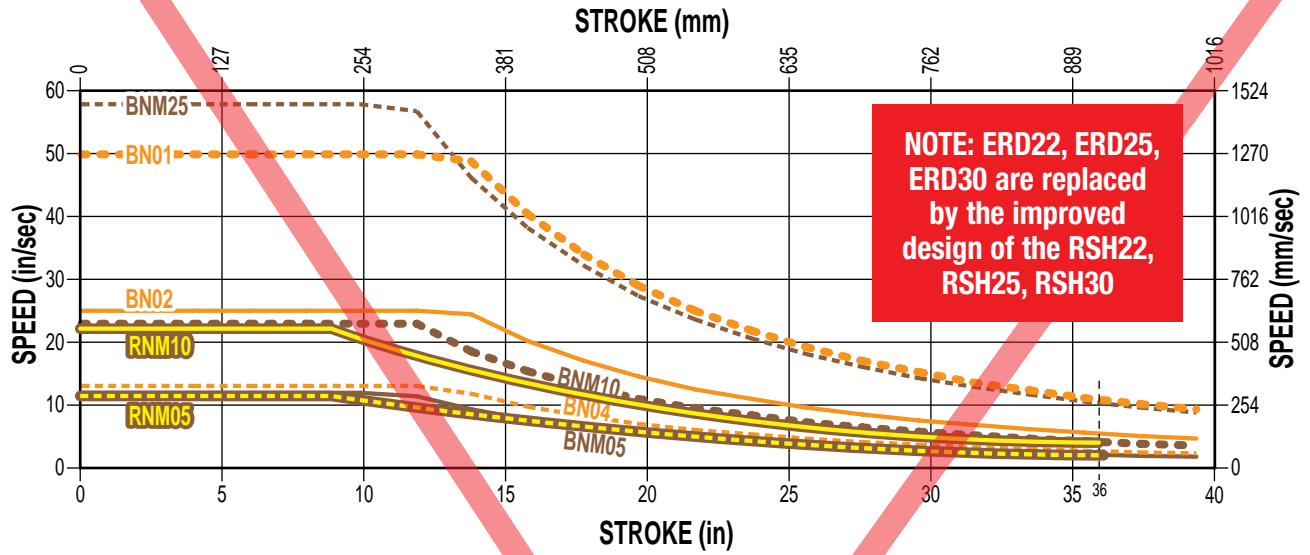

## MAXIMUM THRUST vs STROKE

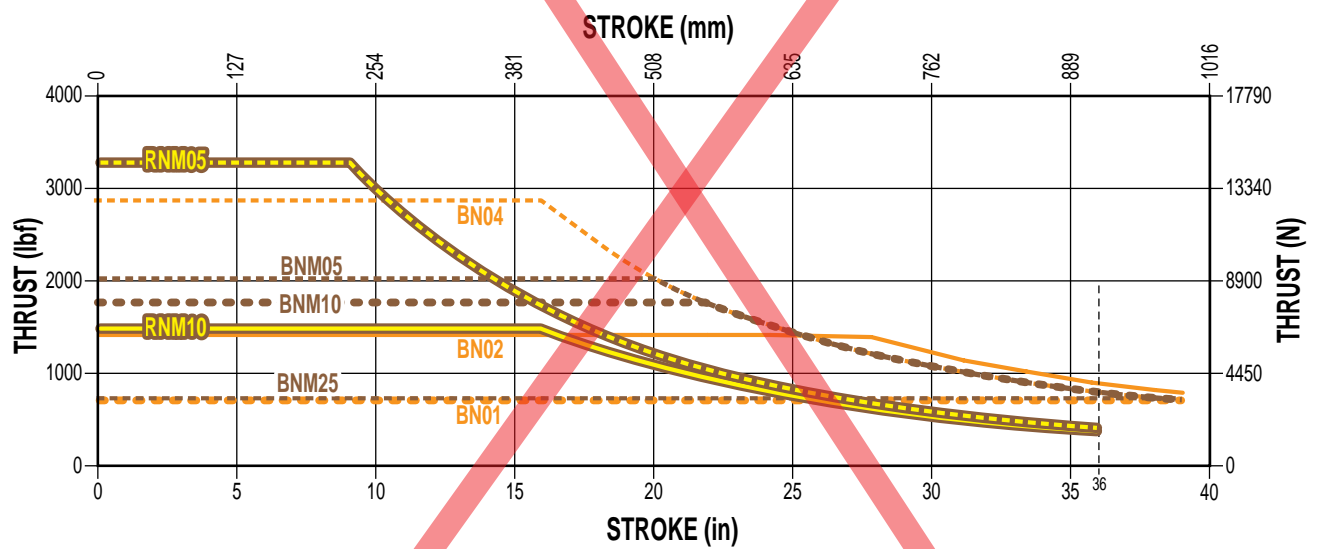

## SCREW LIFE

**NOTE: See L<sub>10</sub> expected life calculation on page ERD\_13**

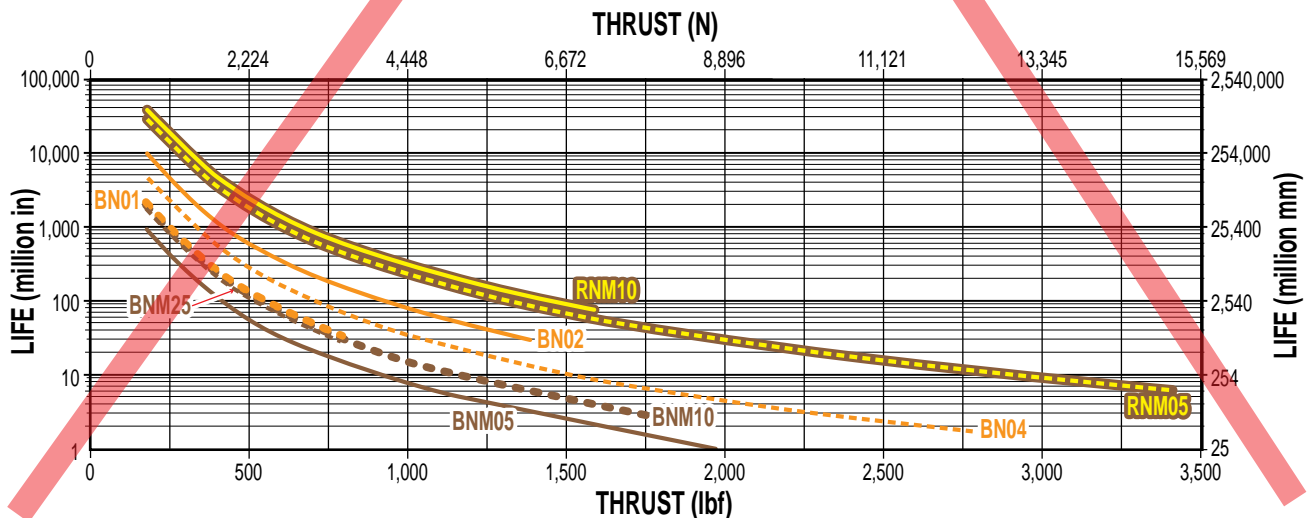

# ERD – Electric Rod-Style Actuator

sizeit.tolomatic.com for fast, accurate actuator selection



SIZE: ERD30

PERFORMANCE

## CRITICAL SPEED CAPACITY

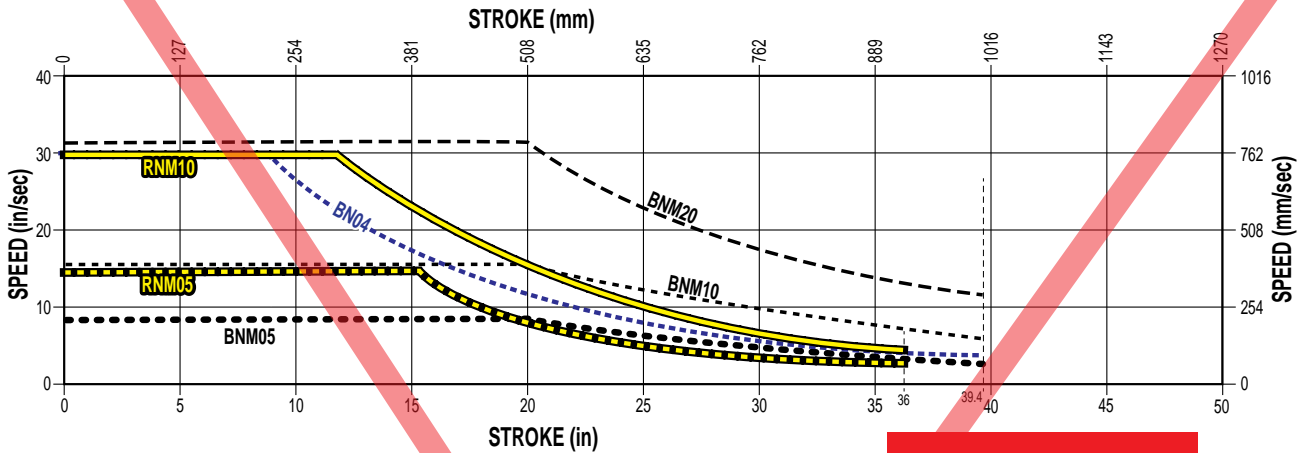

**NOTE: ERD22, ERD25, ERD30 are replaced by the improved design of the RSH22, RSH25, RSH30**

## MAXIMUM THRUST vs STROKE

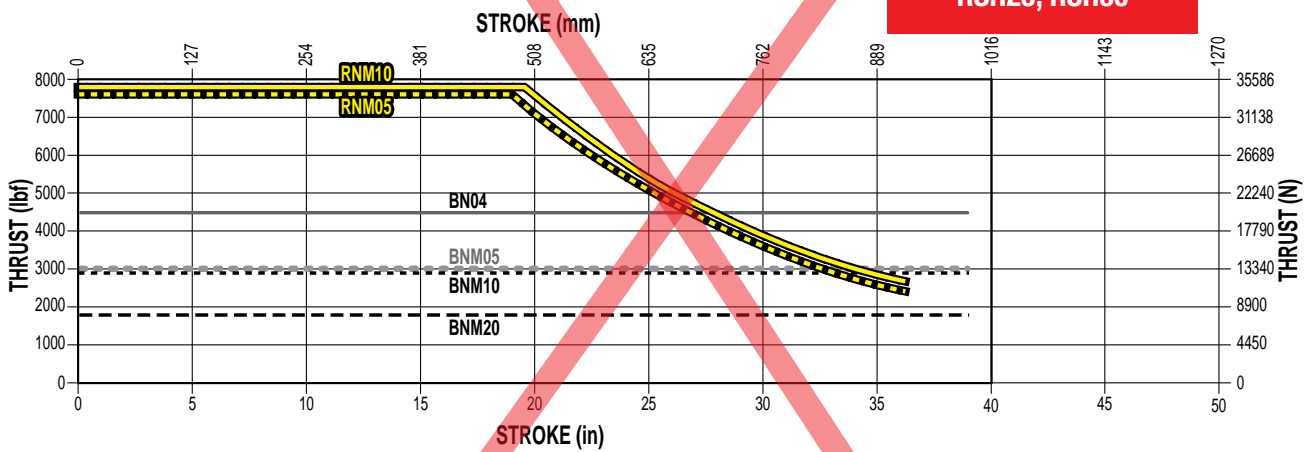

## SCREW LIFE

**NOTE: See L<sub>10</sub> expected life calculation on page ERD\_13**

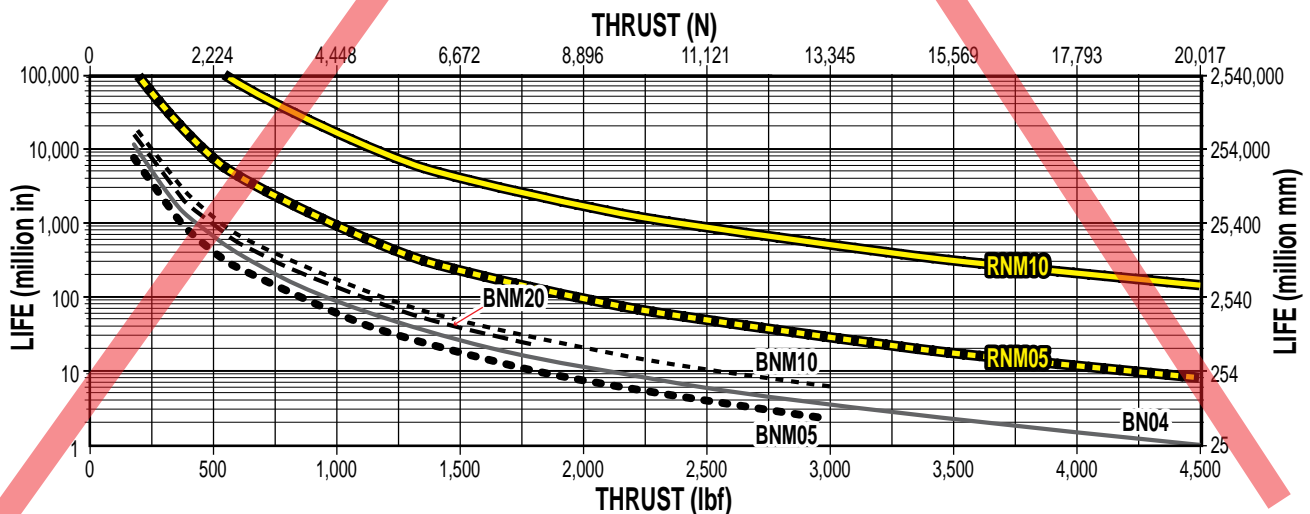



# ERD – Electric Rod-Style Actuator

**NOTE: ERD22, ERD25, ERD30 are replaced by the improved design of the RSH22, RSH25, RSH30**

Go to [www.tolomatic.com](http://www.tolomatic.com) for fast, accurate actuator selection



SIZE: 22, 25, 30

## RE-LUBRICATION RECOMMENDATION:

**ERD22, ERD25, ERD30:** ERD Lubrication requirements for electric actuators depend on the motion cycle (velocity, force, duty cycle), type of application, ambient temperature, environmental surrounding and various other factors. For many general purpose applications, Tolomatic ball screw actuators are typically considered lubricated for life unless otherwise specified, such as those actuator models outfitted with a re-lubrication feature. For roller screw or ball screw actuators outfitted with a re-lubrication feature, Tolomatic recommends to re-lubricate the actuator at least once per year or every 1,000,000 cycles, whichever comes first, to maximize service life. For more demanding applications such as pressing, high frequency or other highly stressed applications, the re-lubrication interval

for these actuators will vary and will need to be more frequent. In these demanding applications, it is recommended to execute at least 5 full stroke moves every 5,000 cycles of operation (or more frequent if possible) to re-distribute the grease within the actuator.

Re-lubricate with Tolomatic Grease into the grease zerk located on the rod end.

	ERD22	ERD25	ERD30
Qty. 2.5g + (0.010x \$mm)	2.5g + (0.010x \$mm)	4.8g + (0.010x \$mm)	5.3g + (0.018x \$mm)
Qty. 0.09oz + (0.009x \$in)	0.09oz + (0.009x \$in)	0.17oz + (0.009x \$in)	0.19oz + (0.016x \$in)

\$ = Stroke length (mm or in)

**⚠ In some applications oil may leak from the grease zerk. In contamination sensitive applications replace grease zerk with plug.**



**USE THE TOLOMATIC SIZING AND SELECTION SOFTWARE AVAILABLE ON-LINE AT [www.tolomatic.com](http://www.tolomatic.com) OR... CALL TOLOMATIC AT 1-800-328-2174.** We will provide any assistance needed to determine the proper actuator for the job.

## OPTION: GD2 – GUIDED ERD

### LOAD VS EXTENDED LENGTH

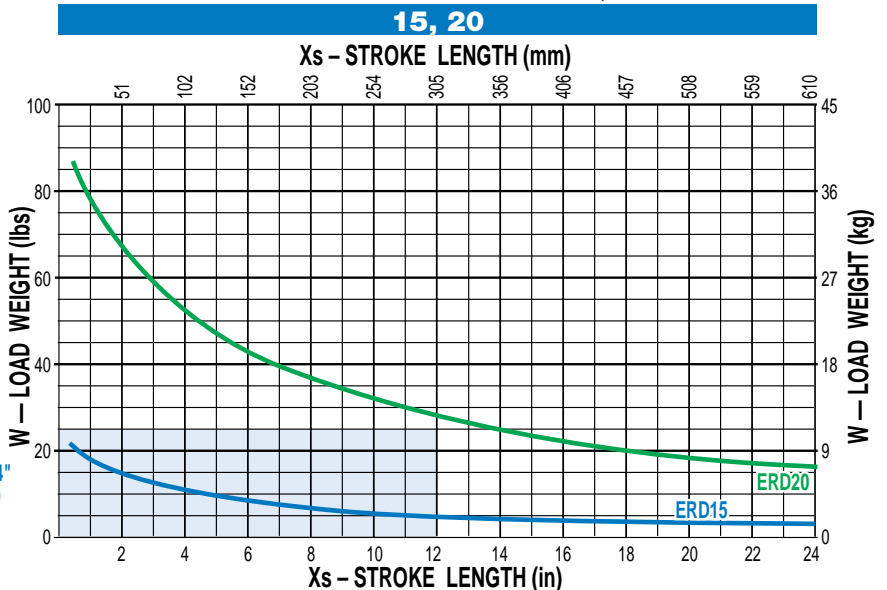
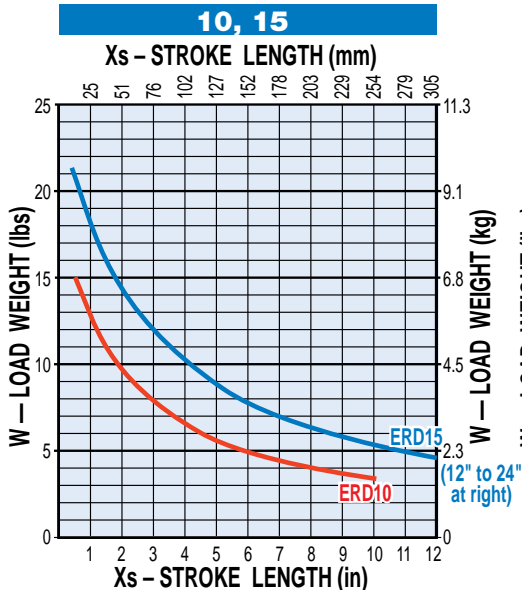
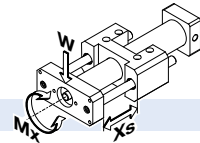



**BENDING MOMENTS**

**10, 15**

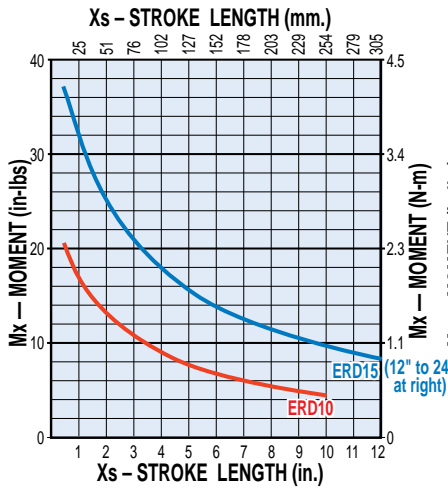

**15, 20**

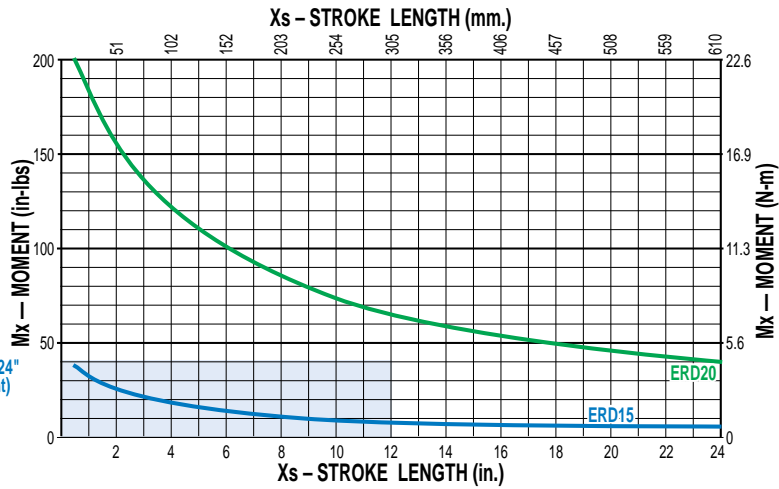

**GUIDE ROD DEFLECTION**

**10**

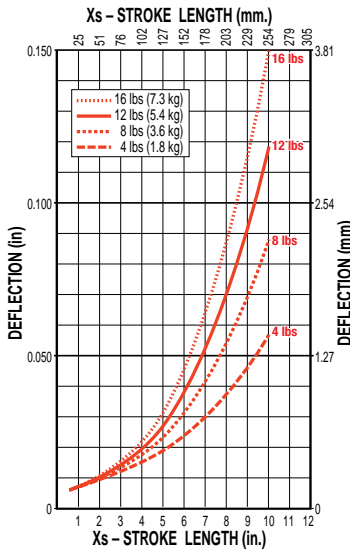

**NOTE:** Deflection is measured at the tooling plate. Excessive deflection may impact actuator life. Contact Tolomatic for assistance

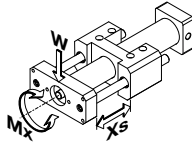

**15**

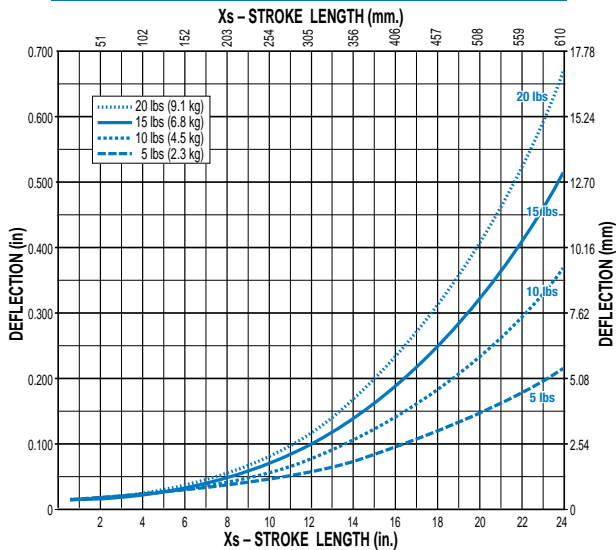

**20**

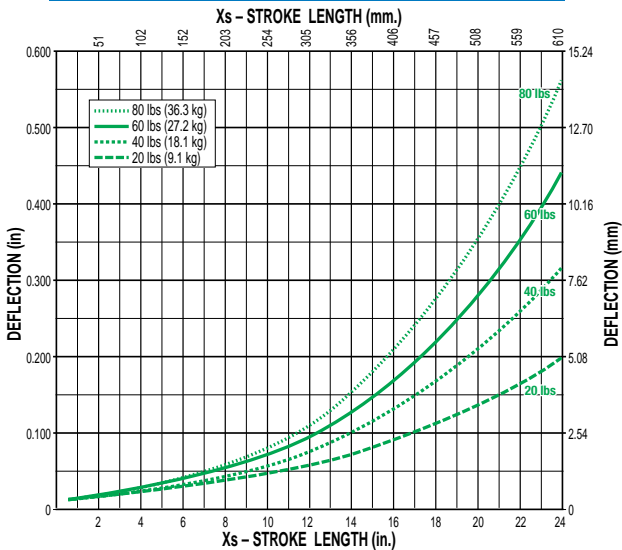

# ERD – Electric Rod-Style Actuator

SIZE: 10, 15, 20

3D CAD available at [www.tolomatic.com](http://www.tolomatic.com)  
Always use configured CAD solid model  
to determine critical dimensions



## ACTUATOR

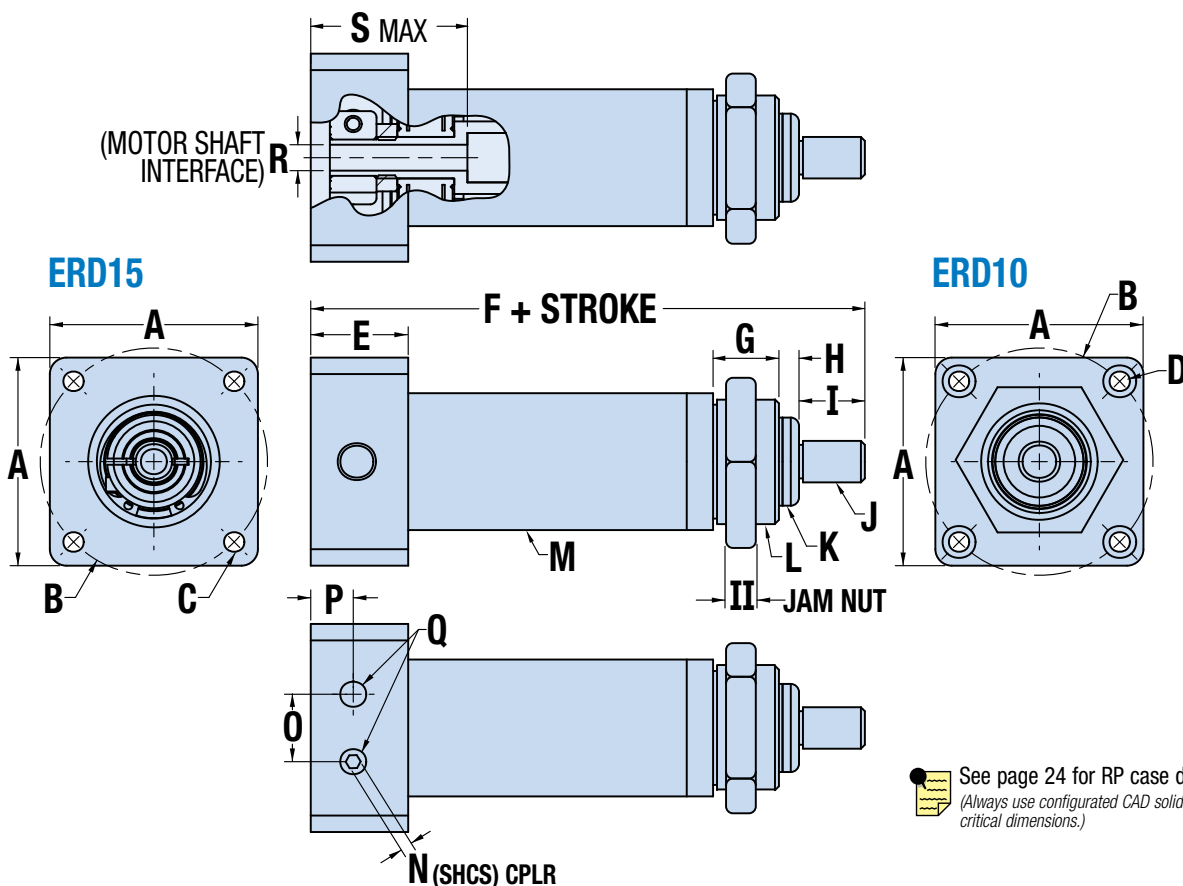

See page 24 for RP case dimensions.  
(Always use configured CAD solid model for critical dimensions.)

	ERD10	ERD15	ERD20
A	40.13	56.39*	*
B	Ø43.82	Ø66.68*	*
C	-	M4 x 0.7*	*
D	Ø3.91	-	*
E	18.80	21.59*	*
F	106.7	137.2*	*
G	12.70	15.24	18.75
H	3.89	3.89	3.89
I	12.70	19.05	19.05
J**	M8 x 1.25	M12 x 1.75	M16 x 2.0
K	Ø17.42	Ø26.40	Ø33.60

	ERD10	ERD15	ERD20
L	M24 x 1.5	M34 x 1.5	M44 x 1.5
II	6.00	8.00	8.00
M	Ø26.42	Ø41.61	Ø52.20
N	2.50	2.50*	*
O	13.00	13.00	23.37
P	8.20	7.57*	*
Q	(2) M6 x 1.0 1.0 ±7.9	(2) M6 x 1.0 ±12.7	(2) M6 x 1.0 ±12.7
R	Ø5.00	Ø6.35*	*
S	27.94	31.75*	*

Dimensions in millimeters

	ERD10	ERD15	ERD20
A	1.580	2.220*	*
B	Ø1.725	Ø2.625*	*
C	-	M4 x 0.7*	*
D	Ø.154	-	*
E	0.740	0.850*	*
F	4.20	5.40*	*
G	0.500	0.600	0.750
H	0.153	0.153	0.153
I	0.500	0.750	0.750
J**	M8 x 1.25	M12 x 1.75	M16 x 2.0
K	Ø.686	Ø1.041	Ø1.323

	ERD10	ERD15	ERD20
L	M24 x 1.5	M34 x 1.5	M44 x 1.5
II	0.236	0.315	0.315
M	Ø1.040	Ø1.638	Ø2.051
N	0.098	0.098*	*
O	0.512	0.512	0.920
P	0.323	0.298*	*
Q	(2) M6 x 1.0 1.0 ±.31	(2) M6 x 1.0 ±.50	(2) M6 x 1.0 ±.50
R	Ø.197	Ø.250*	*
S	1.100	1.250*	*

Dimensions in inches

\* This dimension is determined by motor choice.  
\*\* Note: If ordering as a replacement actuator for use with rod end options, order Code RA1 to receive M10x1.25 rod end thread on the ERD15  
Note: If ordering as a replacement actuator for use with rod end options, order Code RA1 to receive M16x1.5 rod end thread on the ERD20



# ERD – Electric Rod-Style Actuator

SIZE: 10, 15, 20

3D CAD available at [www.tolomatic.com](http://www.tolomatic.com)  
Always use configured CAD solid model  
to determine critical dimensions



**DIMENSIONS**

## IP67 - IP69K OPTION DIMENSIONS

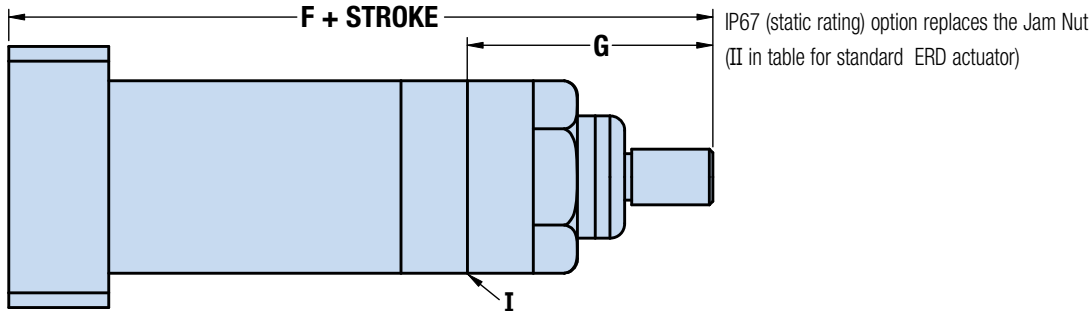

### IP67 OPTION

	ERD10	ERD15	ERD20
F	121.8	152.4*	204.8*
G	44.17	53.0	72.5
I	Surface for mounting options		

### IP67 OPTION

	ERD10	ERD15	ERD20
F	4.79	6.00*	8.06*
G	1.739	2.09	2.85
I	Surface for mounting options		

### IP69K OPTION

	ERD10	ERD15	ERD20
F	128.1	164.8	204.8*
G	50.52	65.7	72.5
I	Surface for mounting options		

### IP69K OPTION

	ERD10	ERD15	ERD20
F	5.04	6.49	8.06*
G	1.989	2.59	2.85
I	Surface for mounting options		

Dimensions in millimeters

Dimensions in inches



\*Dimension shown is with Tolomatic AMS1xx motor hardware YMH option will determine this dimension.

## FFG - FRONT FLANGE\*

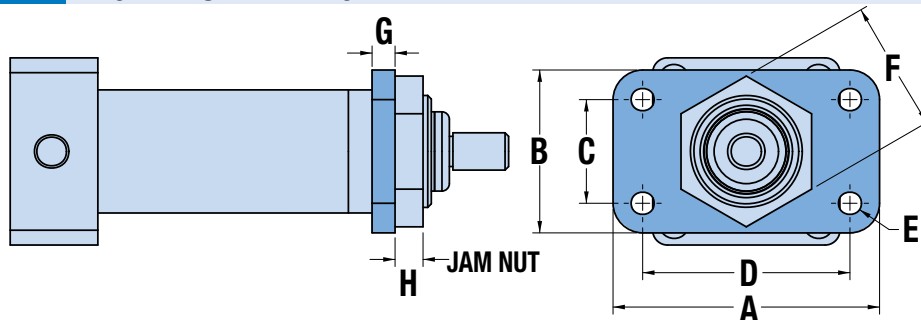

	ERD10	ERD15	ERD20
A	57.15	63.50	88.90
B	34.93	44.45	57.15
C	22.23	31.75	44.45
D	44.45	50.80	76.20
E	Ø4.93	Ø5.61	Ø7.14
F	28.00	40.00	48.08
G	4.93	4.93	4.93
H	6.00	8.00	8.00

Dimensions in millimeters

	ERD10	ERD15	ERD20
A	2.250	2.500	3.500
B	1.375	1.750	2.250
C	0.875	1.250	1.750
D	1.750	2.000	3.000
E	Ø0.194	Ø0.221	Ø0.281
F	1.102	1.575	1.890
G	0.194	0.194	0.194
H	0.236	0.315	0.315

Dimensions in inches



\*The FFG option for the ERD Sizes 10, 15, and 20 comes loosely tightened from Tolomatic to allow for ease of installation in the field. The Jam Nut must be tightened after ERD installation according to the procedure in ERD Parts Sheet 2190-4001

# ERD – Electric Rod-Style Actuator

SIZE: 10, 15, 20

3D CAD available at [www.tolomatic.com](http://www.tolomatic.com)  
Always use configured CAD solid model  
to determine critical dimensions



## SRE SPHERICAL ROD END

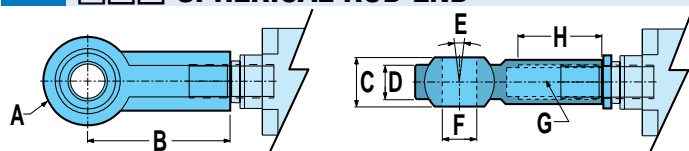

Size	A Ø	B	C	D	E	F Ø	G	H
10	22.3	36.0	12.0	8.8	10°	8.0	M8x1.25	17.0
15	28.0	43.0	14.0	10.5	10°	10.0	M10x1.25	20.0
20	42.0	64.0	21.0	15.0	10°	16.0	M16x1.5	28.0

Dimensions in millimeters

Allows for slight misalignment between the load and the actuator (radial and angular).  
Uses an industry-standard bearing.

Size	A Ø	B	C	D	E	F Ø	G	H
10	0.88	1.42	0.47	0.34	10°	0.31	M8x1.25	0.67
15	1.10	1.69	0.55	0.41	10°	0.39	M10x1.25	0.79
20	1.65	2.52	0.83	0.59	10°	0.63	M16x1.5	1.10

Dimensions in inches

## CLV CLEVIS ROD END

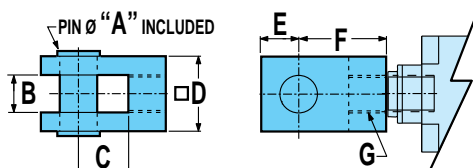

Size	A Ø	B	C	D	E	F	G
10	8.0	8.0	16.0	16.0	10.0	32.0	M8x1.25
15	10.0	10.0	20.0	20.0	12.0	40.0	M10x1.25
20	16.0	16.0	32.0	32.0	19.0	64.0	M16x1.5

Dimensions in millimeters

Used with the externally threaded rod end when the actuator has to compensate for misalignment or pivot about an axis.

\* Note: ERD15 rod end options use M10 X 1.25 thread, not the standard M12 X 1.75 rod end thread. When ordering an attachment with the actuator the actuator will come with M10x1.25 thread.  
Note: ERD20 rod end options use M16 X 1.5 thread, not the standard M16 X 2.0 rod end thread. When ordering an attachment with the actuator the actuator will come with M16x1.5 thread.

Size	A Ø	B	C	D	E	F	G
10	0.32	0.32	0.63	0.63	0.39	1.26	M8x1.25
15	0.39	0.39	0.79	0.79	0.47	1.57	M10x1.25
20	0.63	0.63	1.26	1.26	0.75	2.52	M16x1.5

Dimensions in inches

## ALC ALIGNMENT COUPLER

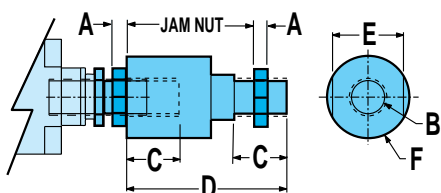

Used in combination with the externally threaded rod end to provide smooth motion and extends actuator life by preventing binding caused by angular or axial misalignment. Not available for use with clevis or trunnion mounts, as they must be rigidly mounted.

Size	A	B	C	D	E	F
15	6.0	M10x1.25	20.0	73.0	30.0	32.0
20	8.0	M16x1.5	32.0	108.0	41.0	45.0

Dimensions in millimeters

Size	A	B	C	D	E	F
15	0.24	M10x1.25	0.79	2.87	1.18	1.26
20	0.31	M16x1.5	1.26	4.25	1.61	1.77

Dimensions in inches

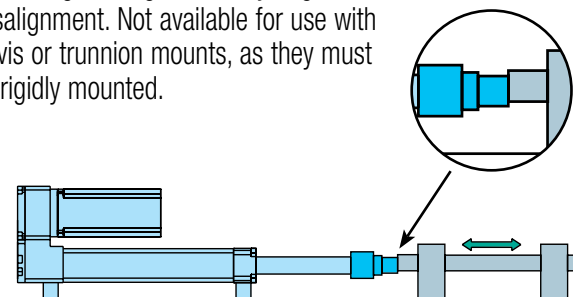

Note: ERD15 rod end options use M10 X 1.25 thread, not the standard M12 X 1.75 rod end thread. When ordering an attachment with the actuator the actuator will come with M10x1.25 thread.  
Note: ERD20 rod end options use M16 X 1.5 thread, not the standard M16 X 2.0 rod end thread. When ordering an attachment with the actuator the actuator will come with M16x1.5 thread.

# ERD – Electric Rod-Style Actuator

SIZE: 10, 15, 20

3D CAD available at [www.tolomatic.com](http://www.tolomatic.com)  
Always use configured CAD solid model  
to determine critical dimensions



**DIMENSIONS**

## FM2 - FOOT MOUNT

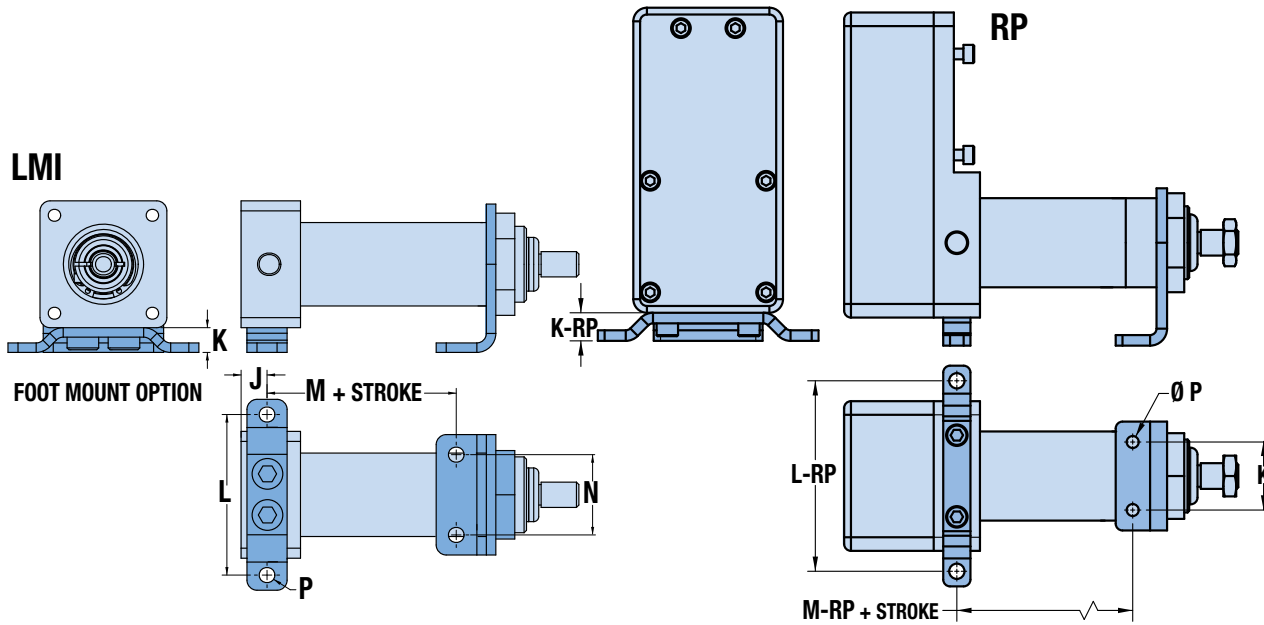

	ERD10	ERD15	ERD20	
				BNM20
J	8.20	7.57	—	
K	7.82	10.31	14.46	
L	50.80	66.04	82.55	
M	59.87	80.39	81.28	109.86
N	25.4	31.75	31.75	
P	Ø4.93	Ø5.61	Ø7.14	
K-RP	—	13.11	12.70	
L-RP	—	88.90	93.35	
M-RP	—	77.15	66.95	

Dimensions in millimeters

	ERD10	ERD15	ERD20	
				BNM20
J	0.323	0.298	—	
K	0.308	0.406	0.569	
L	2.00	2.600	3.250	
M	2.357	3.165	3.200	4.325
N	1.00	1.250	1.25	
P	Ø.194	Ø.221	Ø.281	
K-RP	—	0.516	0.500	
L-RP	—	3.500	3.675	
M-RP	—	3.038	2.636	

Dimensions in inches



# ERD – Electric Rod-Style Actuator

SIZE: 10, 15, 20

3D CAD available at [www.tolomatic.com](http://www.tolomatic.com)  
Always use configured CAD solid model  
to determine critical dimensions



## TRM/TRR - TRUNNION MOUNT

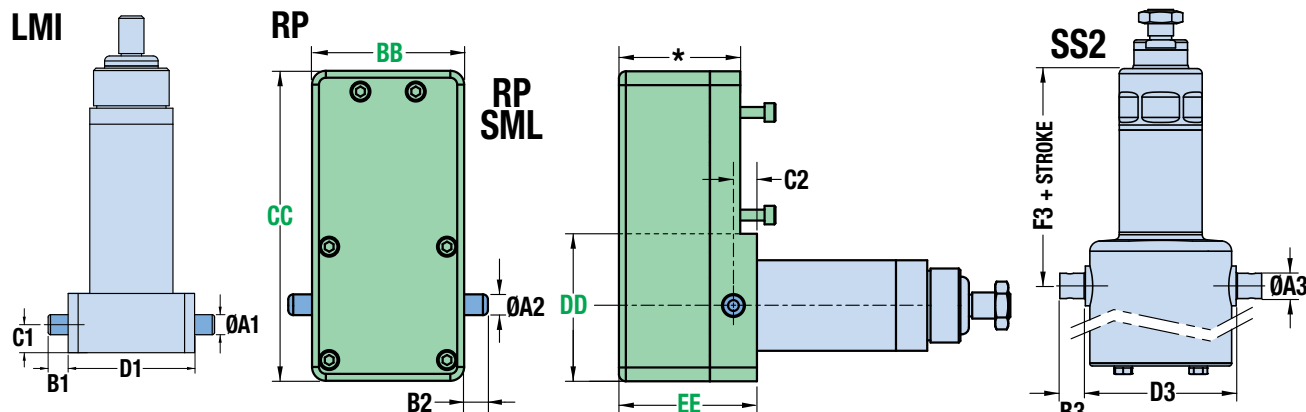

\*Dimension is variable dependent on YMH motor code.

## PCD - REAR CLEVIS (RP)

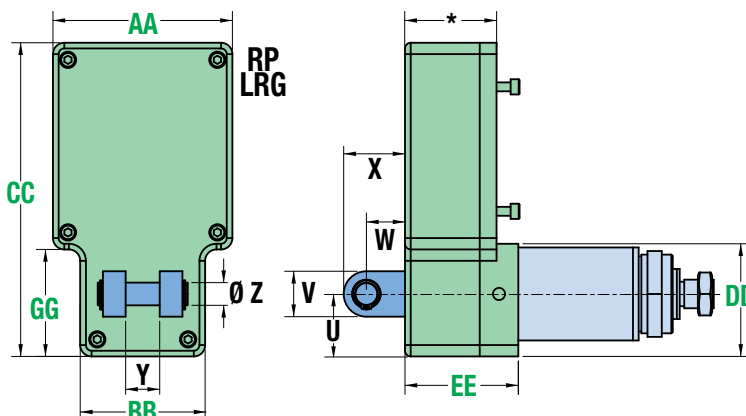

TRM	ERD10	ERD15	ERD20
ØA1	Ø8.000 +0.015 -0.006	Ø12.000 +0.005 0.000	Ø15.997 Ø15.982
B1	6.4	10.9	19.0
C1	9.9	10.8	25.1
D1	40.1	56.4	60.0

Dimensions in millimeters

TRR	ERD10	ERD15	ERD20
ØA1	0.2500 +0.0002 0.0000	0.375 +0.0007 +0.0003	0.6245 0.6240
B1	0.25	0.43	0.75
C1	0.39	0.43	0.99
D1	1.58	2.22	2.36

Dimensions in inches

TRM	ERD15	ERD20
ØA2	Ø12.000 +0.018 -0.007	Ø16.00 / Ø15.98
ØA3	Ø11.987 / Ø11.975	Ø15.98 / Ø15.95
B2	10.9	19.1
B3	12.7	16.0
C2	10.8	10.8
D3	93.4	94.7
F3	123.3	136.4
F3 (BNM20)	-	165.1

Dimensions in millimeters

TRR	ERD15	ERD20
ØA2	0.3750 +0.0002 -0.0000	0.6245 / 0.6240
ØA3	0.4719 / 0.4714	0.629 / 0.628
B2	0.43	0.75
B3	0.50	0.63
C2	0.43	0.42
D3	3.68	3.73
F3	4.85	5.37
F3 (BNM20)	-	6.50

Dimensions in inches

	15		20		22	25\30
	PCD1	PCD2	PCD1	PCD2	PCD2	PCD2
U SML	34.93	34.93	34.93	34.93	50.17	65.33
U LRG	--	--	34.93	34.93	50.17	76.68
V	25.40	24.00	25.40	24.00	24.00	40.01
W	21.56	21.56	21.59	21.59	21.59	34.93
X	34.26	33.55	34.29	33.58	33.58	54.91
Y	19.05	27.99	19.05	27.99	27.99	59.99
Z	12.687 / 12.675	11.99 / 11.97	12.687 / 12.675	11.99 / 11.97	11.99 / 11.97	19.99 / 19.97
AA SML	69.85	69.85	69.85	69.85	95.25	123.19
AA LRG	--	--	100.33	100.33	117.48	146.05
BB	--	--	69.85	69.85	95.25	146.05
CC SML	142.37	142.37	142.37	142.37	208.00	250.55
CC LRG	--	--	175.39	175.39	223.88	308.28
DD SML	58.72	58.72	62.36	62.36	91.44	123.75
DD LRG	--	--	62.99	62.99	91.44	135.10
EE	63.40	63.40	63.40	63.40	66.73	76.05
GG	--	--	59.82	59.82	76.43	--

Dimensions in millimeters

	15		20		22	25\30
	PCD1	PCD2	PCD1	PCD2	PCD2	PCD2
U SML	1.375	1.375	1.375	1.375	1.975	2.572
U LRG	--	--	1.375	1.375	1.975	3.019
V	1.000	0.945	1.000	0.945	0.945	1.575
W	0.849	0.849	0.850	0.850	0.850	1.375
X	1.349	1.321	1.350	1.322	1.322	2.162
Y	0.750	1.102	0.750	1.102	1.102	2.362
Z	.4995 / .4990	.4719 / .4714	.4995 / .4990	.4719 / .4714	.4719 / .4714	.7869 / .7864
AA SML	2.750	2.750	2.750	2.750	3.750	4.850
AA LRG	--	--	3.950	3.950	4.625	5.750
BB	--	--	2.750	2.750	3.750	5.750
CC SML	5.605	5.605	5.605	5.605	8.189	9.864
CC LRG	--	--	6.905	6.905	8.814	12.137
DD SML	2.312	2.312	2.455	2.455	3.600	4.872
DD LRG	--	--	2.480	2.480	3.600	5.319
EE	2.496	2.496	2.496	2.496	2.627	2.994
GG	--	--	2.355	2.355	3.009	--

Dimensions in inches

# ERD – Electric Rod-Style Actuator

SIZE: 10, 15, 20

3D CAD available at [www.tolomatic.com](http://www.tolomatic.com)  
Always use configured CAD solid model  
to determine critical dimensions



**DIMENSIONS**

**SS2 – STAINLESS-STEEL BODY WITH PROTECTIVE MOTOR COVER AND IP69K UPGRADE**

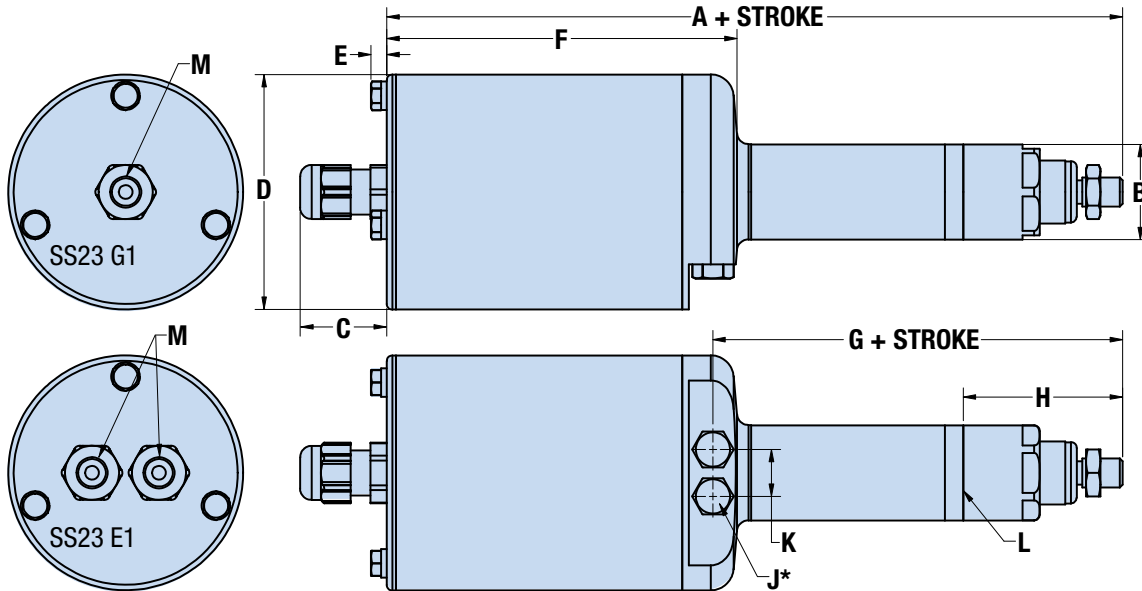

	ERD10	ERD15	ERD20	
				BNM20
A	204.0	282.70	311.4	339.98
B	26.42	41.61	52.10	
C	24.00	24.00	24.00	
D	65.10	89.00	89.00	
E	4.39	5.27	5.27	
F	100.99	134.98	171.64	
G	113.56	143.76	164.80	193.37
H	44.17	53.04	72.48	
J*	M6 x 1.0	M6 x 1.0	M6 x 1.0	
K	13.00	13.00	23.37	
L	Surface for mounting options			

Dimensions in millimeters

	ERD10	ERD15	ERD20	
				BNM20
A	8.03	11.130	12.26	13.385
B	1.040	1.638	2.051	
C	0.945	0.945	0.945	
D	2.563	3.504	3.504	
E	0.173	0.207	0.207	
F	3.976	5.314	6.758	
G	4.471	5.660	6.488	7.613
H	1.739	2.088	2.853	
J*	M6 x 1.0	M6 x 1.0	M6 x 1.0	
K	0.512	0.512	0.920	
L	Surface for mounting options			

Dimensions in inches

M	Code	Encoder Code	Available cable exit options:
	SS21	G1, E1	no cord grips 1/2" NPT tapped hole
	SS22	G1, E1	no cord grips M20 x 1.5 tapped hole
	SS23	G1	1 cord grip (motor, no encoder)
		E1	2 cord grips (motor, with encoder)

\*Unit ships standard with hex bolts in these tapped holes

NOTE: IP67 is a static rating

⊗ SS2 is not available for the 22, 25, 30 size

# ERD – Electric Rod-Style Actuator

SIZE: 10, 15, 20

3D CAD available at [www.tolomatic.com](http://www.tolomatic.com)  
Always use configured CAD solid model  
to determine critical dimensions



## GD2 – GUIDED ERD

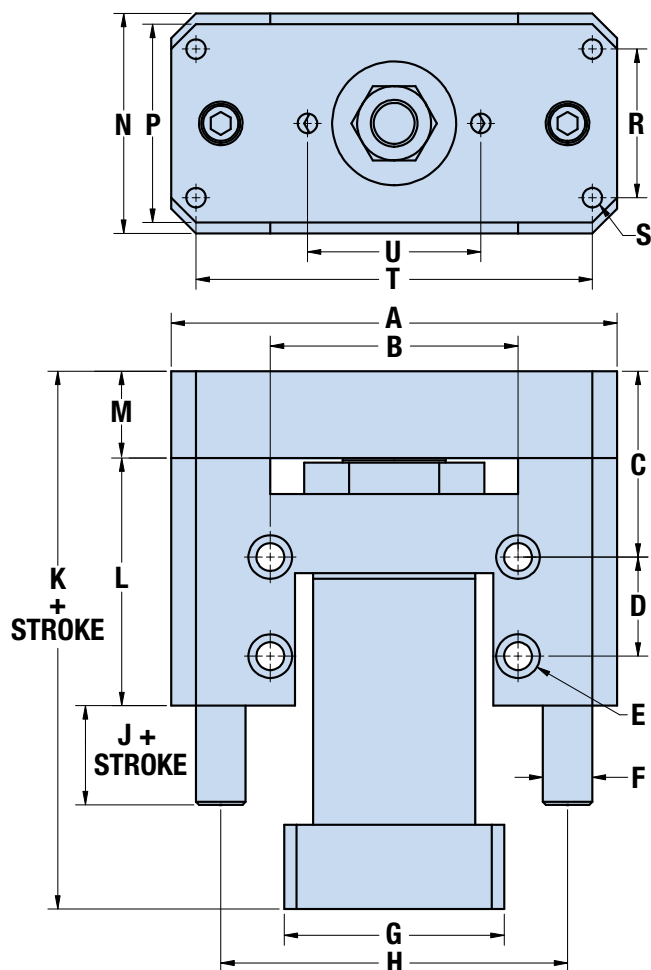

### GUIDED ERD WITH IP67 OPTION

ERD STROKE IS REDUCED BY DIMENSION "V"

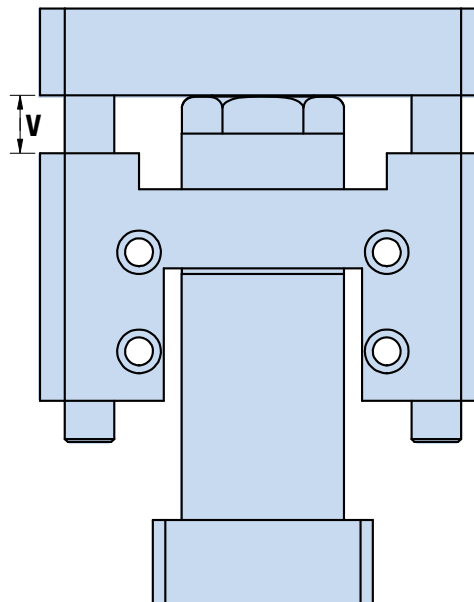

	ERD10	ERD15	ERD20
A	88.90	114.30	149.86
B	50.80	63.50	82.55
C	31.75	47.63	63.50
D	25.40	25.40	50.8
E Ø	5.61	7.14	8.74
F Ø	9.53	12.70	19.05
G	40.13	56.39*	*
H	69.85	88.90	117.48
J	25.40	25.40	38.10
K	107.80	137.87*	*
L	50.80	63.50	127.00
M	15.88	22.23	25.40
N	40.13	56.39	60.96
P	38.10	50.80	58.42
R	25.40	38.10	38.10
S	M5x0.8	M6x1.0	M8x1.25
T	76.20	101.60	127.00
U	34.93	44.45	57.15
V	14.91	14.86	30.47

Dimensions in millimeters

	ERD10	ERD15	ERD20
A	3.500	4.500	5.900
B	2.000	2.500	3.250
C	1.250	1.875	2.500
D	1.000	1.000	2.000
E Ø	0.221	0.281	0.344
F Ø	0.375	0.500	0.750
G	1.580	2.220*	*
H	2.750	3.500	4.625
J	1.000	1.000	1.500
K	4.244	5.428*	*
L	2.000	2.500	5.000
M	0.625	0.875	1.000
N	1.580	2.220	2.400
P	1.500	2.000	2.300
R	1.000	1.500	1.500
S	M5x0.8	M6x1.0	M8x1.25
T	3.000	4.000	5.000
U	1.375	1.750	2.250
V	0.587	0.585	1.200

Dimensions in inches

\*This dimension is determined by motor choice.

# ERD – Electric Rod-Style Actuator

SIZE: 22, 25, 30

3D CAD available at [www.tolomatic.com](http://www.tolomatic.com)  
Always use configured CAD solid model  
to determine critical dimensions



**DIMENSIONS**

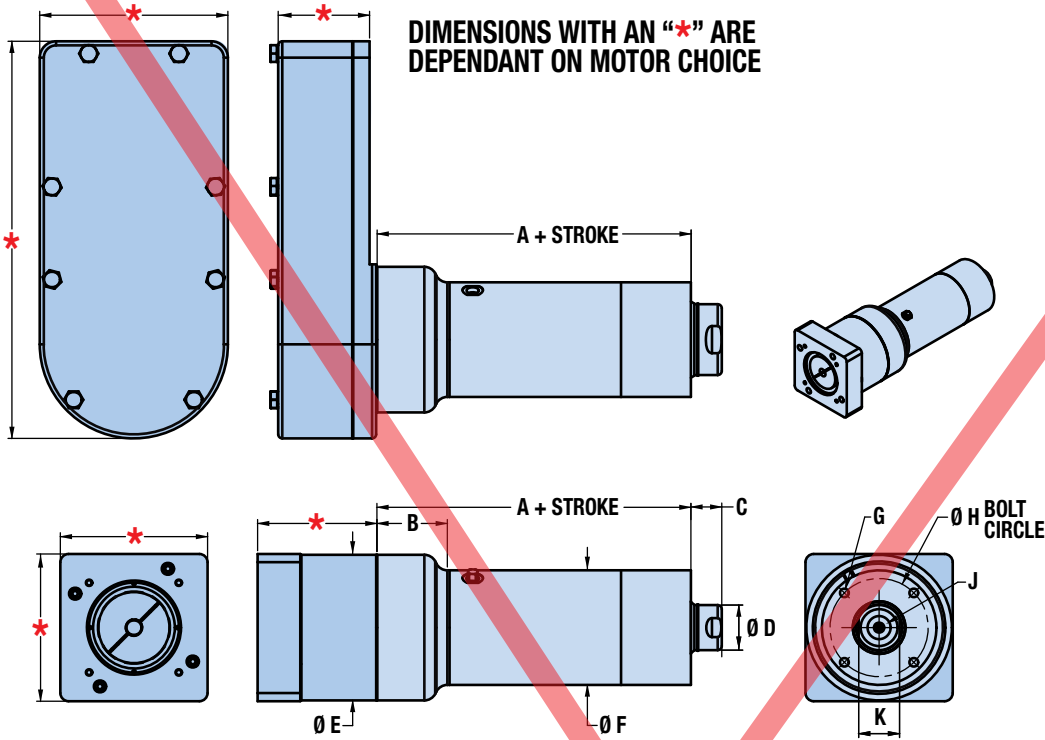

**NOTE: ERD22, ERD25, ERD30 are replaced by the improved design of the RSH22, RSH25, RSH30**

	A	B	C	Ø D	Ø E	Ø F	G	Ø H	J	K
ERD22	187.33	42.88	17.8	27.99	74.9	56.9	M6 x 1.0 - 6H $\downarrow$ 12.0	45.49	M12 x 1.25 $\downarrow$ 22.2	25.40
ERD25	243.74	54.66	23.9	35.00	113.0	88.9	M8 x 1.25 - 6H $\downarrow$ 16.0	76.20	M20 x 1.5 $\downarrow$ 25.4	31.75
ERD30	243.74	54.66	23.9	54.99	113.0	88.9	M8 x 1.25 - 6H $\downarrow$ 16.0	76.20	M27 x 2.0 $\downarrow$ 33.0	50.80

Dimensions in millimeters

	A	B	C	Ø D	Ø E	Ø F	G	Ø H	J	K
ERD22	7.375	1.688	0.70	1.102	2.95	2.24	M6 x 1.0 - 6H $\downarrow$ 0.47"	1.791	M12 x 1.25 $\downarrow$ 0.88"	1.000
ERD25	9.596	2.152	0.94	1.378	4.45	3.50	M8 x 1.25 - 6H $\downarrow$ 0.63"	3.000	M20 x 1.5 $\downarrow$ 1.00"	1.250
ERD30	9.596	2.152	0.94	2.165	4.45	3.50	M8 x 1.25 - 6H $\downarrow$ 0.63"	3.000	M27 x 2.0 $\downarrow$ 1.30"	2.000

Dimensions in inches

## FFG OPTION

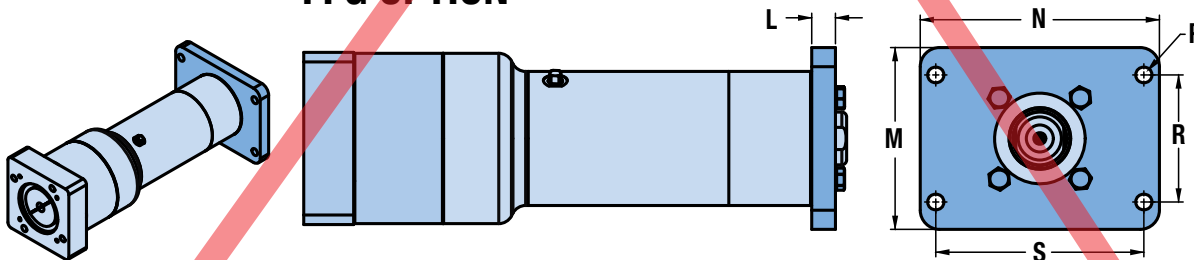

	L	M	N	P	R	S
ERD22	10.2	69.9	98.6	7.1	50.8	76.2
ERD25	15.7	120.7	158.8	10.7	84.3	138.2
ERD30	15.7	120.7	158.8	10.7	84.3	138.2

Dimensions in millimeters

	L	M	N	P	R	S
ERD22	0.40	2.75	3.88	0.28	2.00	3.00
ERD25	0.62	4.75	6.25	0.42	3.32	5.44
ERD30	0.62	4.75	6.25	0.42	3.32	5.44

Dimensions in inches



# ERD – Electric Rod-Style Actuator

SIZE: 22, 25, 30

3D CAD available at [www.tolomatic.com](http://www.tolomatic.com)  
Always use configured CAD solid model to determine critical dimensions



## FM2 OPTION

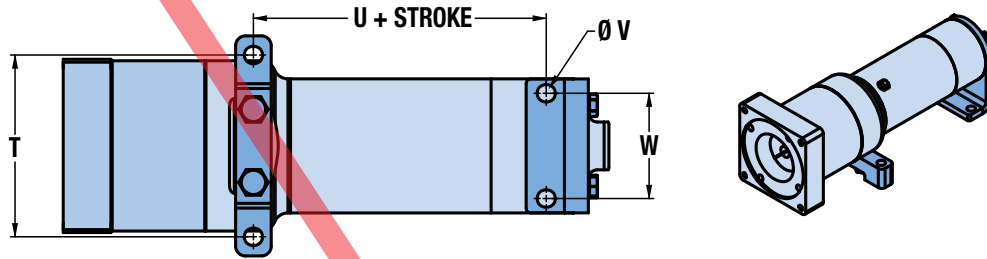

	T	U	ØV	W
ERD22	88.9	145.0	7.11	44.5
ERD25	120.7	194.3	11.99	69.9
ERD30	120.7	194.3	11.99	69.9

Dimensions in millimeters

	T	U	ØV	W
ERD22	3.50	5.71	0.280	1.75
ERD25	4.75	7.65	0.472	2.75
ERD30	4.75	7.65	0.472	2.75

Dimensions in inches

**NOTE: ERD22, ERD25, ERD30 are replaced by the improved design of the RSH22, RSH25, RSH30**

## TRR OPTION

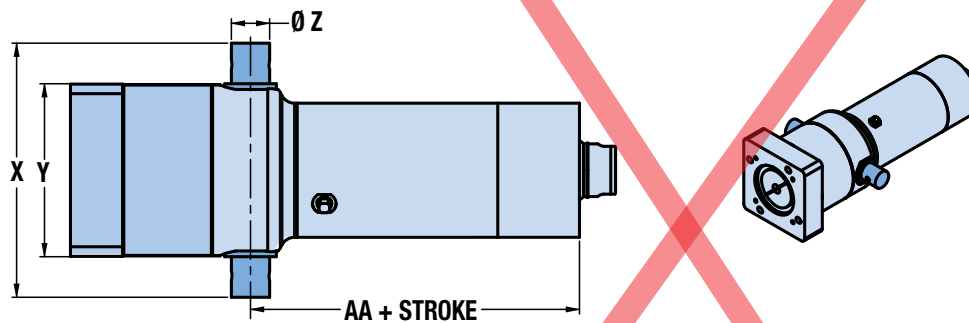

	X	Y	ØZ	AA
ERD22	109.68	77.67	16.00	15.95
ERD25	168.66	114.81	25.39	25.36
ERD30	168.66	114.81	25.39	25.36

Dimensions in millimeters

	X	Y	ØZ	AA
ERD22	4.318	3.058	0.630	0.629
ERD25	6.640	4.520	1.000	0.999
ERD30	6.640	4.520	1.000	0.999

Dimensions in inches

## HYG1 OPTION

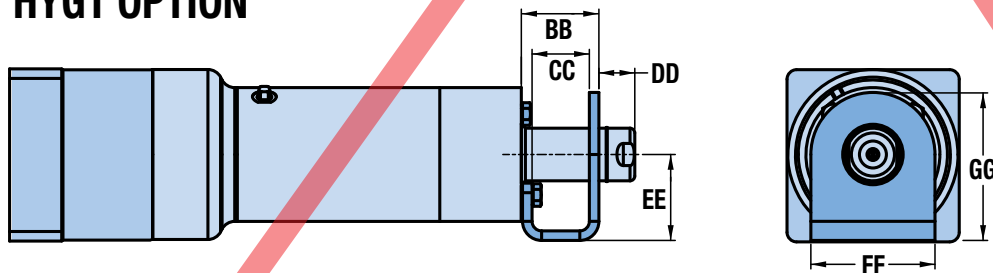

	BB	CC	DD	EE	FF	GG
ERD22	41.4	27.9	12.7	50.8	56.9	79.2
ERD25	51.6	38.1	23.9	57.2	82.6	98.6
ERD30	51.6	38.1	23.9	57.2	82.6	98.6

Dimensions in millimeters

	BB	CC	DD	EE	FF	GG
ERD22	1.63	1.10	0.50	2.00	2.24	3.12
ERD25	2.03	1.50	0.94	2.25	3.25	3.88
ERD30	2.03	1.50	0.94	2.25	3.25	3.88

Dimensions in inches

# ERD – Electric Rod-Style Actuator

SIZE: 10, 15

3D CAD available at [www.tolomatic.com](http://www.tolomatic.com)  
Always use configured CAD solid model to determine critical dimensions



**DIMENSIONS**

## ALTERNATIVE MOTOR DIMENSIONS

### MOTOR DIMENSIONS – NEMA MOTOR MOUNT

The ERD 10 & 15 sizes are designed to accommodate NEMA standard stepper and servo motors.

ACTUATOR	SIZE
ERD10	NEMA17
ERD15	NEMA23

The only limiting factors are the motor shaft diameter and length. NEMA standard motors from the companies in the table at right have been found to be compatible with the ERD actuator. (☞ \*NOT a complete listing)

ERD Compatible NEMA Motor Suppliers*
Anaheim Automation
Animatics
Applied Motion Products
Automation Direct
Cool Muscle
Electrocraft
Fastech
IMS / Scheider Electric
JVL
LIN Engineering
Nippon Pulse Motor
Omega
Oriental Motor
Parker
Sanyo Denki
+ Others

**!** When any motor has been selected for use with the ERD actuator it is important to confirm the motor is compatible with the dimensions in the table below.

		ERD10	ERD15	ERD10	ERD15
MOTOR SHAFT LENGTH	MIN.	12.7	12.7	0.50	0.50
	MAX.	27.94	31.75	1.100	1.250
DIAMETER	B	5.00	6.35	0.197	0.250
BOLT HOLE CIRCLE	ØC	43.82	66.68	1.725	2.625
	SPACING	D	30.99	47.14	1.220
MOTOR PILOT DIAMETER MAX.	E	24.90	39.37	0.980	1.550
	HEIGHT MAX.	F	3.30	3.30	0.130

Dimensions in millimeters

Dimensions in inches

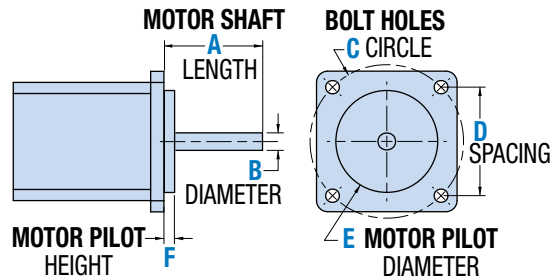

### MOTOR CHOICES - YOUR MOTOR HERE

SELECT A COMPLETE SYSTEM FROM TOLOMATIC OR ADD ANY MOTION SYSTEM TO OUR ACTUATORS

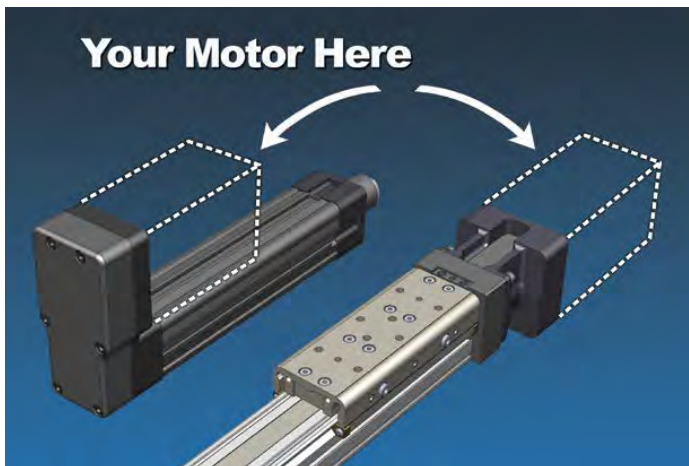

### "YOUR MOTOR HERE" MADE-TO-ORDER MOTOR MOUNTS.

- Select a high-performance Tolomatic electric actuator and we'll provide a motor-specific interface for your motor. With our online database, you can select from over 60 motor manufacturers and hundreds of models.

Visit [www.tolomatic.com/ymh](http://www.tolomatic.com/ymh) to find your motor/actuator match!

The ERD 15, 20, 22, 25 & 30 sizes utilize Tolomatic's YMH (Your Motor Here) program. See [www.tolomatic.com/ymh](http://www.tolomatic.com/ymh) or consult Tolomatic sales at 1-800-328-2174 for details.

Configure an actuator and a complete motion control system today using Tolomatic's easy-to-use on-line sizing & selection



Available FREE at [www.tolomatic.com](http://www.tolomatic.com)

# ERD – Electric Rod-Style Actuator

## SWITCHES

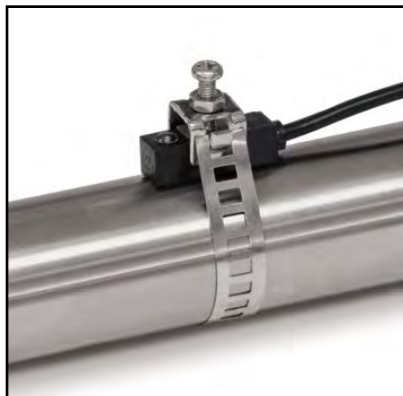

ERD actuators have 6 switch options: reed, solid state PNP (sourcing) or solid state NPN (sinking); normally open; with flying leads or quick-disconnect.

Commonly used for end-of-stroke positioning, these switches allow clamp-on installation anywhere along the entire actuator length. The internal magnet, located on the thrust tube, is a standard feature. Switches can be installed in the field at any time.

Switches are used to send digital signals to PLC (programmable logic controller), TTL, CMOS circuit or other controller device. Switches contain reverse polarity protection. Solid state QD cables are shielded; shield should be terminated at flying lead end.

All switches are CE rated, IP67 rated and are RoHS compliant. Switches feature bright red or green LED signal indicators.



	Order Code	Lead	Switching Logic	Power LED	Signal LED	Operating Voltage	**Power Rating (Watts)	Switching Current (mA max.)	Current Consumption	Voltage Drop	Leakage Current	Temp. Range	Shock / Vibration	IP Rating
REED	<b>R</b> <b>Y</b>	5m	SPST Normally Open	—	Red	5 - 240 AC/DC	**10.0	100mA	—	3.0 V max.	—	14 to 158°F	30 G / 9 G	67
	<b>R</b> <b>K</b>	QD*												
SOLID STATE	<b>T</b> <b>Y</b>	5m	PNP (Sourcing) Normally Open	—	Green	5 - 30 VDC	**3.0	200mA	8 mA @ 24V	1.0 V max.	0.01 mA max.	[-10 to 70°C]	50 G / 9 G	67
	<b>T</b> <b>K</b>	QD*												
	<b>K</b> <b>Y</b>	5m	NPN (Sinking) Normally Open	—	Red									
	<b>K</b> <b>K</b>	QD*												

\*QD = Quick-disconnect Enclosure classification IEC 529 IP67 (NEMA 6)

CABLES: Robotic grade, oil resistant polyurethane jacket, PVC insulation

**⚠️ \*\*WARNING:** Do not exceed power rating (Watt = Voltage x Amperage). Permanent damage to sensor will occur.

## SWITCH INSTALLATION - FIELD REPLACEMENT INSTRUCTIONS

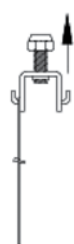

**STEP 1:**  
Loosen screw and nut.



**STEP 2:**  
Place sensor and wrap the band around the ERD cylinder. Position the hook with the nearest hole on the band and mark the hole with a permanent marker.

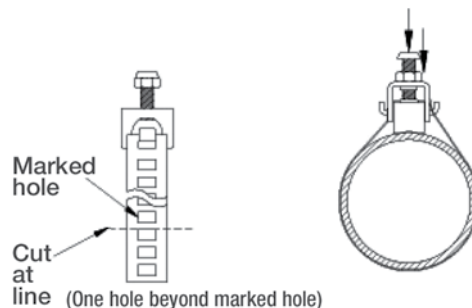

**STEP 3:**  
Remove mounting assembly. Cut the band at the nearest edge of the next hole. (The one that's furthest away from the mounting head.)



**STEP 4:**  
Replace the sensor and mounting assembly. Wrap the band and put the chosen hole on the hook. Position the switch and tighten. Tighten nut for steadying.

# ERD – Electric Rod-Style Actuator

## SWITCHES

### WIRING DIAGRAMS

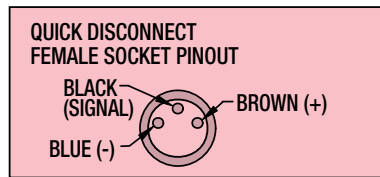
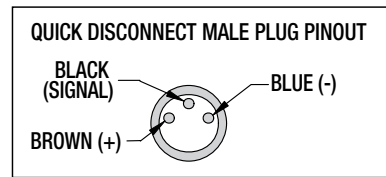
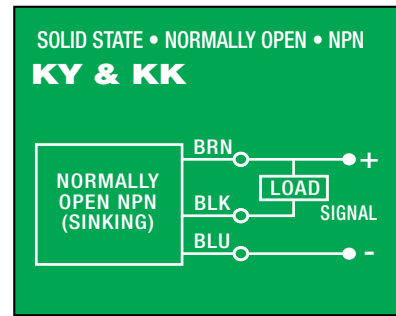
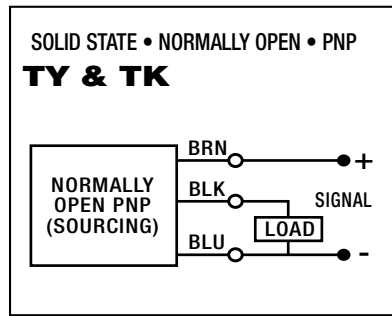
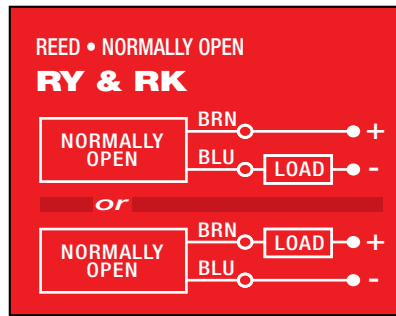

## SWITCH DIMENSIONS

☐ **Y** - direct connect

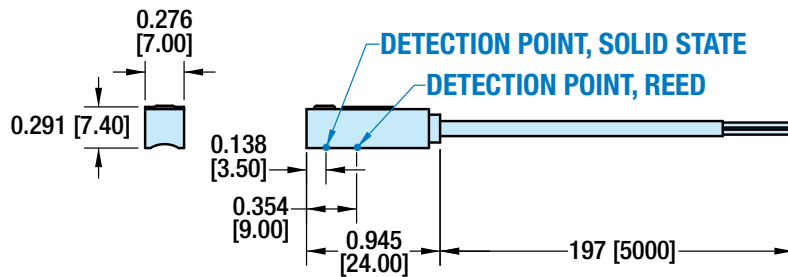

☐ **K** - QD (Quick-disconnect) switch

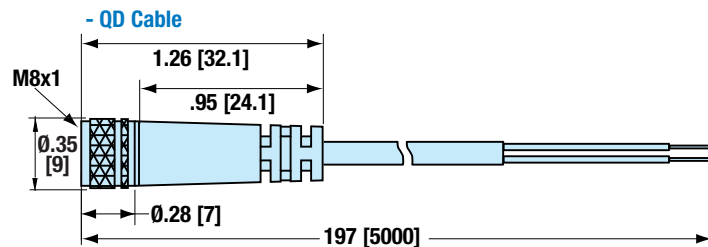

**SWITCH CLAMP**

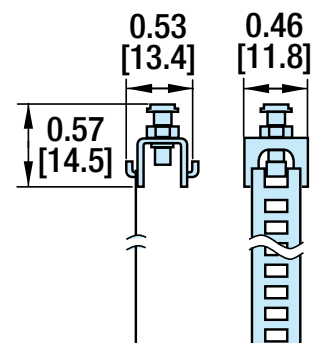



# APPLICATION DATA WORKSHEET

Fill in known data. Not all information is required for all applications

## ORIENTATION

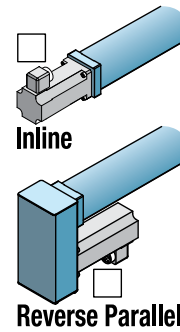
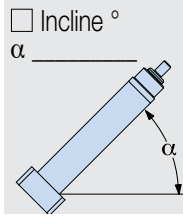
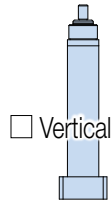
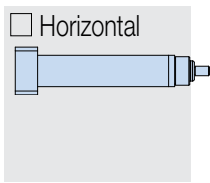

Load supported by actuator OR  Load supported by other mechanism

## MOVE PROFILE

### EXTEND

Move Distance \_\_\_\_\_

inch (US conventional)  millimeters (Metric)

Move Time \_\_\_\_\_ sec

Max. Speed \_\_\_\_\_

in/sec  mm/sec

Dwell Time After Move \_\_\_\_\_ sec

### RETRACT

Move Distance \_\_\_\_\_

inch  millimeters

Move Time \_\_\_\_\_ sec

Max. Speed \_\_\_\_\_

in/sec  mm/sec

Dwell Time After Move \_\_\_\_\_ sec

**NO. OF CYCLES** \_\_\_\_\_

per minute  per hour

**HOLD POSITION?**  Required  Not Required

After Move  During Power Loss

**NOTE:** If load or force changes during cycle use the highest numbers for calculations

### EXTEND

#### LOAD

lb. (U.S. Standard)  kg. (Metric)

#### FORCE

lbf. (U.S. Standard)  N (Metric)

### RETRACT

#### LOAD

lb. (U.S. Standard)  kg. (Metric)

#### FORCE

lbf. (U.S. Standard)  N (Metric)

## STROKE LENGTH

inch (US conventional)  millimeters (Metric)

## PRECISION

Repeatability \_\_\_\_\_  
 inch  millimeters

## OPERATING ENVIRONMENT

Temperature, Contamination, Water, etc.

## MOTION PROFILE

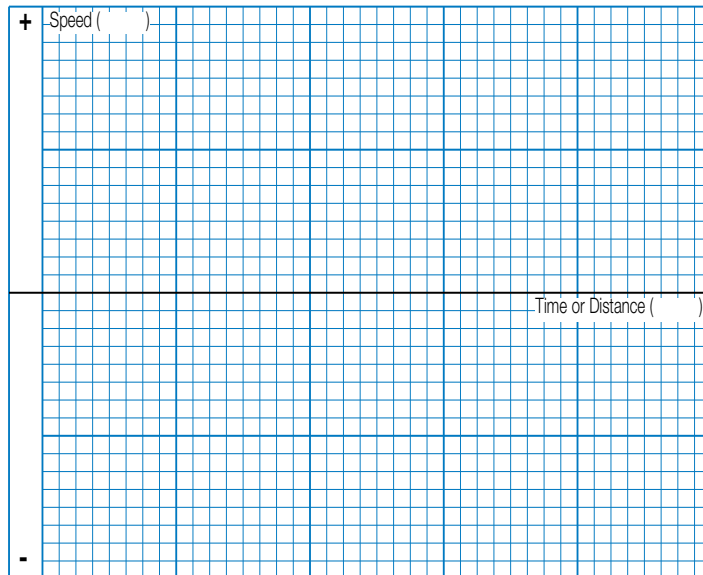

Graph your most demanding cycle, including accel/decel, velocity and dwell times. You may also want to indicate load variations and I/O changes during the cycle. Label axes with proper scale and units.

## CONTACT INFORMATION

Name, Phone, Email  
Co. Name, Etc.



**USE THE TOLOMATIC SIZING AND SELECTION SOFTWARE AVAILABLE ON-LINE AT [www.tolomatic.com](http://www.tolomatic.com) OR... CALL TOLOMATIC AT 1-800-328-2174.** We will provide any assistance needed to determine the proper actuator for the job.

**FAX 1-763-478-8080**

**EMAIL [help@tolomatic.com](mailto:help@tolomatic.com)**



## Selection Guidelines

### 1 ESTABLISH MOTION PROFILE

Using the application stroke length, desired cycle time, loads and forces, establish the motion profile details including linear velocity and thrust in each of its segments.

### 2 SELECT ACTUATOR SIZE AND SCREW TYPE

Based on the required velocities and thrust select a size and screw type and lead of the ERD actuator.

### 3 VERIFY CRITICAL SPEED OF THE SCREW

Verify that the application's peak linear velocity does not exceed the critical speed value for the size and lead of the screw selected.

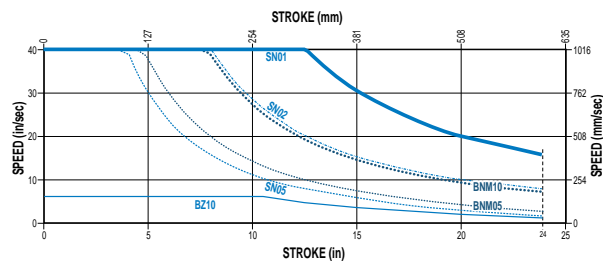

### 4 VERIFY AXIAL BUCKLING STRENGTH OF THE SCREW

Verify that the peak thrust does not exceed the critical buckling force for the size of the screw selected.

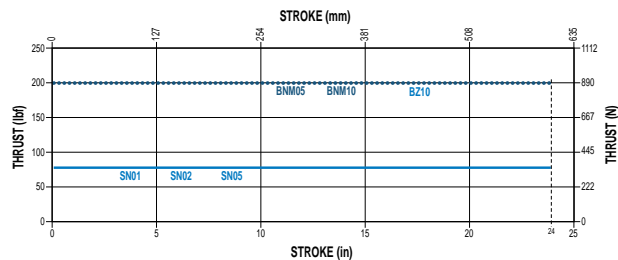

### 5 ESTABLISH TOTAL TORQUE REQUIREMENTS

Calculate total system inertia. The peak and RMS torque required from the motor to overcome internal friction, external forces and accelerate/decelerate the load.

### 6 VERIFY PV VALUE (IF ACME)

Verify that the PV value does not exceed the PV value for the size of the screw selected.

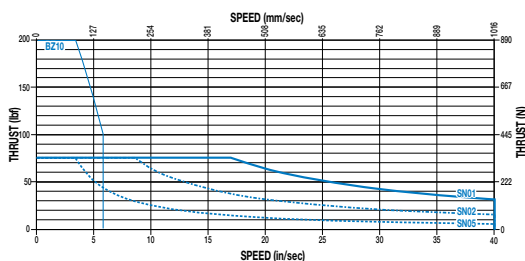

### 7 CALCULATE LIFE (IF BALL SCREW)

Determine the practical load of the system to calculate the L10 estimated life.

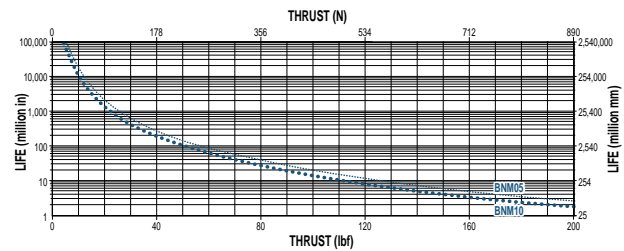

### 8 DETERMINE IF LOAD GUIDANCE IS NEEDED

If application requires carrying a load, anti-rotate, a tooling plate or there is risk of side loading the rod, choose the guided option. (GD2) Available sizes: 10, 15, 20

### 9 DETERMINE IF INGRESS PROTECTION AGAINST DUST AND WATER IS NEEDED.

If actuator is in contact with dust particulate, water or wash-down environment choose the IP67 or IP69K option.

(IP67) Available sizes: 10, 15, 20;

(IP69K) Available sizes: [15 & 20 with SS2], 22, 25, 30

### 10 DETERMINE IF ENVIRONMENT IS CORROSIVE OR WASH DOWN

If corrosion resistance is required for 10-20 sizes, choose from two options of stainless steel components

- (SS1) ERD with all stainless steel components
- (SS2) ERD with all stainless steel components and protective motor enclosure.

For 22, 25 & 30 sizes choose (IP69K)

### 11 SELECT MOUNTING AND SENSOR CHOICES

Mounting options include: (TRR) trunnion mount, (FFG) front flange mount, (FM2) foot mount. 6 sensor choices include: reed, solid state PNP or NPN, all in normally open, with flying leads or quick-disconnect couplers.

### 12 SELECT ACTUATOR CONTROL SOLUTION

Add an extremely easy to use drive and motor combination to power the actuator.



## SERVICE PARTS ORDERING

### ERD ACTUATOR REPLACEMENT KITS

Code	Description	ERD SIZE		
		10	15	20
FFG	Front Flange Mount Kit	2191-1025	2192-1025	2193-1025
FM2	Foot Mount Kit	2191-9001	<sup>1</sup> 2192-9001	<sup>2</sup> 2193-9001
TRR	<sup>3</sup> Trunnion Mount	0610-1044 (order 2)	6000-1785 (order 2)	2193-1018 (order 2)
IP67	<sup>4</sup> IP67 Kit	2191-9201	2192-9201	2193-9201
IP69K	<sup>4</sup> IP69K Kit	–	2192-9221	2193-9202
GD2	Guide Kit	Order via configurator code: GD2ERD__SM__ . __		

<sup>1</sup> REPLACEMENT ONLY: If ERD15 unit was built with SS2 option, foot mount kit 2192-9203 is required.

<sup>2</sup> REPLACEMENT ONLY: If ERD20 unit was built with RP SS1 option, foot mount kit 2193-9209 is required.

<sup>3</sup> REPLACEMENT ONLY: Trunnion mount option not available with SS2 option

<sup>4</sup> REPLACEMENT ONLY: If used on an actuator that was not originally built with the IP67 option the thrust rod will retract below the

Cap/Seal and may damage the seal

Code	Description	ERD SIZE	
		15	20
RA1	<i>If replacing an actuator with CLV, SRE or ALC rod end option and want to use existing rod end, add <b>RA1</b> to the end of the ordering code for thread compatibility. Do not reorder the rod end option.</i>		

**NOTE: ERD22, ERD25, ERD30 are replaced by the improved design of the RSH22, RSH25, RSH30**

Code	Description	ERD SIZE		
		22	25	30
FFG	Front Flange Mount Kit	2195-9052	2194-9052	2194-9052
FM2	**Foot Mount Kit	2195-9053	2194-9053	2194-9053
TRR	**Trunnion Mount	2195-1071 (order 2)	1150-1411 (order 2)	1150-1411 (order 2)

\*\* REPLACEMENT ONLY

NOTE: IP69K replacement kit not available for ERD22, ERD+25 & ERD30 - return to Tolomatic for service

### ERD SWITCHES

To order switch kits use configuration code for switch preceded by SW and actuator code.

EXAMPLE: **SWERD15KK**

KIT	ACTUATOR	SIZE	SWITCH CODE

Code	Lead	Normally	Sensor Type
<b>R</b> <b>Y</b>	5m (197 in)	Open	Reed
<b>R</b> <b>K</b>	Quick-disconnect		
<b>T</b> <b>Y</b>	5m (197 in)	Open	Solid State PNP
<b>T</b> <b>K</b>	Quick-disconnect		
<b>K</b> <b>Y</b>	5m (197 in)	Open	Solid State NPN
<b>K</b> <b>K</b>	Quick-disconnect		

The example is for 3 Solid State NPN, Normally Open Switches with Quick-disconnect couplers. Each switch is complete with Bracket, Set Screw, Switch and mating QD cable.

# ERD – Electric Rod-Style Actuator



## ORDERING

ERD 15 SN02 SM152-4 LMI ST1

MODEL	
ERD	Rod-Style Actuator

SIZE	
10, 15, 20, 22, 25, 30	

NUT/SCREW COMBINATIONS		
SIZE	CODE	TURNS/in (TPI)
10	SN	01, 02, 05
	BNM	05 mm lead
15	SN	01, 02, 05
	BNM	05, 10 mm lead
20	BNM	05, 10, 20 mm lead
	BZ	10
22	BN	02, 05
	BNM	05, 10, 20 mm lead
25	RNM	05, 10 mm lead
	BN	01, 02, 04
30	BNM	05, 10, 25 mm lead
	RNM	05, 10 mm lead

STROKE LENGTH				
SM_._	Enter desired stroke length in millimeters (25.4mm = 1 inch)			
MAXIMUM STROKE				
SIZE	SN or BN		Roller Nut	
	mm	in	mm	in
10	254.0	10	-	-
15,20	609.6	24	-	-
22	1000.0	39.4	609.6	24
25	1000.0	39.4	914.4	36
30	1219.2	48	914.4	36

Contact Tolomatic with requests for longer strokes

MOTOR MOUNTING	
LMI	In-line motor mount
RP1*	1:1 ratio, Reverse Parallel motor mount
RP2*	2:1 ratio, Reverse Parallel motor mount

\*RP is not available for the 10 size

Not all codes listed are compatible with all options. Contact Tolomatic with any questions.

## OPTION ORDERING

ARI SS1 IP67 FFG KK2 YM

TORQUE	
ST1	Standard torque (LMI or RP)
HT1	High torque (RP only)
<del>22, 25 &amp; 30 size RP TORQUE CHOICES</del>	
ST	Less than 60 in/lbs torque to actuator
HT	More than 60 in/lbs torque to actuator

ACTUATOR GUIDE & ANTI-ROTATE	
GD2	Guided unit with 2 guide shafts & tooling plate
GD2 is always aluminum even when ordered with SS1	
GD2 is not available for 22, 25, 30 size	
ARI	Internal Anti-Rotate for 15, 20, 22, 25, 30 sizes only
ARI not available for 22 BN02, BN05 or 30 RNM05, RNM10	

ENVIRONMENTAL PROTECTION	
SS1	Stainless steel actuator
SS2_*	Stainless steel actuator with protective motor enclosure
SS21	NPT 1/2" conduit thread
SS22	M20x1.5 conduit thread
SS23	Cord grip(s), 1 or 2 grips determined by encoder choice
IP67 & IP69K	See chart below (IP ratings defined on pg. ERD_9)
HYG1	(ERD22, 25 & 30 only) IP69K Ingress protection rating (static), dust protection, high pressure water spray
LUB	Food grade grease
*NOTE: Only Tolomatic motors are available with the SS2 option	
SS2 is not available for 22, 25, 30 size or with GD2 option	
NOTE: ERD 10, 15 & 20: IP69K available only together with SS2 option	

ACTUATOR MOUNTING	
FFG**	Front Flange Mount
TRM	Trunnion Mounting, Rear (metric)
TRR	Trunnion Mounting, Rear (US standard)
FM2**	Foot Mount
§PCD1	Rear Clevis Mounting inch/Imperial pin size
§PCD2	Rear Clevis Mounting metric pin size

\*\*NOTE: Foot Mount and Front Flange Mount are shipped together with the actuator but are not installed by Tolomatic.

§ RP motor mount ONLY: 15, 20, 22, 25, 30 sizes

ROD END	
Externally threaded rod end is standard	
CLV	Clevis Rod End
SRE	Spherical Rod End
ALC	Alignment Coupler Rod End
NOTE: Rod End options above are not available for all ERD sizes. Stainless steel available for the above rod ends in limited sizes. Contact Tolomatic	

For replacement actuator compatible with existing rod end options see RA1 code on pg. 34

SWITCHES**						
TYPE	LOGIC	NORMALLY	QUICK-DISCONNECT	CODE	QUANTITY	LEAD LENGTH
REED	SPST	Open	No	RY	After code enter quantity desired	5 m (16.4 feet)
SOLID STATE	PNP	Open	Yes	RK		
			No	TY		
NPN	Open	Open	Yes	TK	6 in (152mm) to QD connector w/ 5m lead	
			No	KY		
			Yes	KK		

\*\*NOTE: Switches are shipped together with the actuator but are not installed by Tolomatic.

YOUR MOTOR HERE	
YM_._	Motor mount for non-Tolomatic motor. www.tolomatic.com
AM_._	Tolomatic motor: contact factory

### STEPPER & BRUSHLESS SERVO MOTORS

- Motors •Drives •Gearboxes

Tolomatic offers digital servo or stepper drives with motors matched to provide optimal performance with Tolomatic actuators.

Configure an actuator and a complete motion control system today using Tolomatic's easy-to-use on-line sizing & selection



Available FREE at www.tolomatic.com

NOTE: ERD22, ERD25, ERD30 are replaced by the improved design of the RSH22, RSH25, RSH30

Size	IP RATING CHOICES AVAILABLE			USDA Approved Available	MOTOR ENCLOSURE AVAILABLE
	IP40	IP67	IP69K		
10	Std.	YES	YES	-	YES
15	Std.	YES	YES	-	YES
20	Std.	YES	YES	-	YES
22	-	-	Std.	YES	-
25	-	-	Std.	YES	-
30	-	-	Std.	YES	-



# The Tolomatic Difference Expect More From the Industry Leader:



## INNOVATIVE PRODUCTS

Unique linear actuator solutions with Endurance Technology<sup>SM</sup> to solve your challenging application requirements.



## FAST DELIVERY

The fastest delivery of catalog products... Built-to-order with configurable stroke lengths and flexible mounting options.



## ACTUATOR SIZING

Online sizing that is easy to use, accurate and always up-to-date. Find a Tolomatic electric actuator to meet your requirements.



## YOUR MOTOR HERE

Match your motor with compatible mounting plates that ship with any Tolomatic electric actuator.



## LIBRARY

Easy to access CAD files available in the most popular formats to place directly into your assembly.



## TECHNICAL SUPPORT

Extensive motion control knowledge: Expect prompt, courteous replies to any application and product questions from Tolomatic's industry experts.

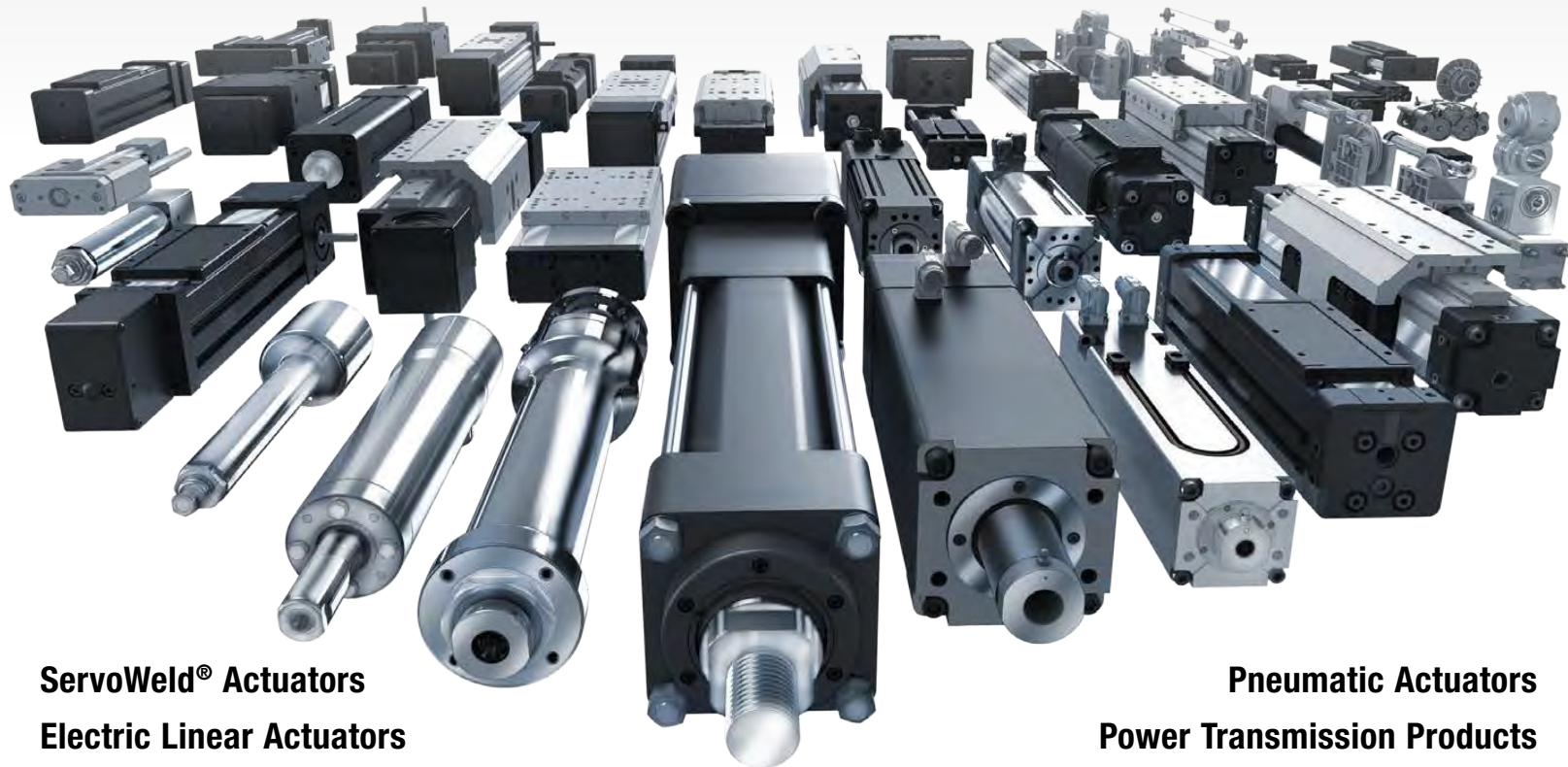

**ServoWeld<sup>®</sup> Actuators**  
**Electric Linear Actuators**

**Pneumatic Actuators**  
**Power Transmission Products**

**Tolomatic**<sup>TM</sup>  
EXCELLENCE IN MOTION

COMPANY WITH  
QUALITY SYSTEM  
CERTIFIED BY DNV GL  
= ISO 9001 =  
Certified site: Hamel, MN

### USA - Headquarters

**Tolomatic Inc.**  
3800 County Road 116  
Hamel, MN 55340, USA  
**Phone:** (763) 478-8000  
Toll-Free: **1-800-328-2174**  
sales@tolomatic.com  
[www.tolomatic.com](http://www.tolomatic.com)

### MEXICO

**Centro de Servicio**  
Parque Tecnológico Innovación  
Int. 23, Lateral Estatal 431,  
Santiago de Querétaro,  
El Marqués, México, C.P. 76246  
**Phone:** +1 (763) 478-8000  
help@tolomatic.com

### EUROPE

**Tolomatic Europe GmbH**  
Elisabethenstr. 20  
65428 Rüsselsheim  
Germany  
**Phone:** +49 6142 17604-0  
help@tolomatic.eu

### CHINA

**Tolomatic Automation Products (Suzhou) Co. Ltd.**  
No. 60 Chuangye Street, Building 2  
Huqiu District, SND Suzhou  
Jiangsu 215011 - P.R. China  
**Phone:** +86 (512) 6750-8506  
TolomaticChina@tolomatic.com

All brand and product names are trademarks or registered trademarks of their respective owners. Information in this document is believed accurate at time of printing. However, Tolomatic assumes no responsibility for its use or for any errors

that may appear in this document. Tolomatic reserves the right to change the design or operation of the equipment described herein and any associated motion products without notice. Information in this document is subject to change without notice.

Visit [www.tolomatic.com](http://www.tolomatic.com) for the most up-to-date technical information